



Xitanium Long-lasting and low maintenance, LED-based light sources are an excellent solution for all lighting applications. For optimal performance, these solutions require reliable drivers matching the long lifetime of the LEDs. The Advance Xitanium LED outdoor driver portfolio offers a range of products specially designed to operate LED solutions in outdoor applications. These drivers are designed for hard-wired integration into outdoor luminaires for the most rugged applications. They operate to specification under wide temperature and electrical ranges to ensure reliability.

Specifications

Input Voltage (Vac)	Output Power (W)	Output Voltage (V)	Output Current (A)	Efficiency@ Max Load and 75°C Case	Max Case Temp. (°C)	Input Current (A)	Max. Input Power (W)	THD @ Max Load (%)	Power Factor @ Max Load	Surge Protection (Combi-Wave, KV)	Envir. Protection Rating	Dimming	Dimming Range (with specified dimmers)	Min. Output Current (A)	Driver Type
120	30	12-40 Class 2 Output	0.1 - 1.2	86	90°C	0.31	35	<15%	>0.95	6	UL damp & dry, Type HL	0-10V Analog Class 1 and 2 Wiring	10% - 100%	0.05	Constant Current
277				86		0.14									

Enclosure

	In. (mm)	Tolerance (mm)
Overall Length (A1)	6.61 (168.0)	± 0.5mm
Mounting Length (A2)	6.06 (153.8)	± 0.5mm
Case Length (A3)	5.50 (139.8)	± 0.5mm
Case Width (B1)	1.78 (45.1)	± 0.5mm
Mounting Length2 (A4)	5.98 (152)	± 0.5mm
Mounting Width (B2)	1.22 (31)	± 0.5mm
Case Height (C1)	1.11 (28.2)	± 1.0mm
Mounting Hole Diameter (D1)	0.20 (5.0)	± 0.3mm
Mounting Hole Diameter (D2)	0.35 (8.8)	± 0.3mm
Center of SimpleSet Antenna (G1)	3.99 (101.5)	± 3.0mm

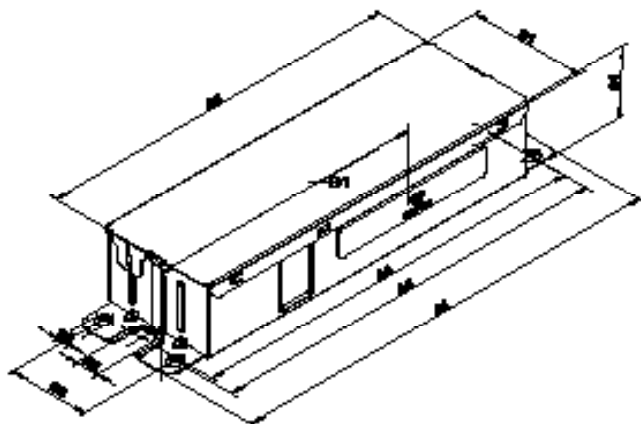

Wiring Diagram

	Wire Length (mm)
Black (Line)	270 (± 30)
White (Neutral)	270 (± 30)
Red (Positive, LED output)	270 (± 30)
Blue (Negative, LED output)	270 (± 30)
Violet (Positive, 0-10V)	270 (± 30)
Pink* (Negative, 0-10V)	270 (± 30)

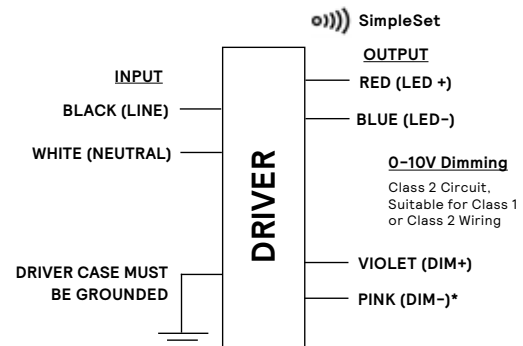

*DIM- will change from GREY to PINK from 2021 onwards.

Warning

- Install in accordance with national and local electrical codes.
- The field-wiring leads or push-in terminals shall be enclosed.



Xitanium XI030C120V040BSJ1

30W 1.2A 0-10V Dimming

Features

- 50,000+ hour lifetime¹
- Programmable output current through SimpleSet
- 6kV combi-wave surge rating to comply with ANSI C28.77-5 CAT C low
- Configurable Driver Thermal Limit (DTL)

Benefits

- Enables long life luminaire designs
- Fast and simple way of programming
- No external surge protection required to pass C82.77-5 CAT low

Application

- Wallpacks
- Parking garages (interior and exterior)
- Floodlights

Electrical Specifications

All the specifications are typical and at 25°C Tcase unless specified otherwise.

Product Data

Order Information	
Full Product Code	XI030C120V040BSJ1, 12NC 929001743313
Line Frequency	50/60Hz
Min. Mains Voltage Operational	108 Vac
Max. Mains Voltage Operational	305 Vac
Output Information	
Maximum Open Circuit Voltage	45Vdc
Output Current Ripple (ripple = peak to average / average)	15% max. @ max. Iout
Output Current Tolerance (in performance window)	<5%
Protections	Short Circuit, Open Circuit Protection for LED + and LED - and Temperature Foldback
Features	
0-10V Dimming	150µA (±3%) source current from driver. See dim curve for detail.
AOC (Adjustable Output Current)	0.1 -1.2 via SimpleSet (Factory Default at 1.05A)
Additional SimpleSet Configurable Features	Adjustable Min Dim Level, OEM Write Protection, Driver Thermal Limit (DTL)
Environment & Approbation	
Operating Ambient Temp. Range	-40°C to +55°C
Max. Case Temperature (Tcase)	85°C for life & 90°C for UL
Agency Approbations	UL 8750, UL Listed
Electromagnetic Compliance	FCC Title 47 Part 15 Class A
Audible Noise	<24dB Class A
Weight	0.795 Lbs/0.361 Kgs

1. Advance Xitanium LED drivers are manufactured to engineering standards correlating to a designed and average life expectancy of 50,000 hours of operation at maximum rated case temperature. Minimum 90% survivals based on MTBF modeling.

Xitanium XI030C120V040BSJ1

30W 1.2A 0-10V Dimming

Electrical Specifications

All the specifications are typical and at 25°C Tcase unless specified otherwise.

0-10V Dimming Curve

Dimming source current from the driver: 150µA (@ 0<Vdim<8V)

Minimum dim level: 10% of Iout

Maximum output voltage on the dimming wires: 12V

The dimming lead leakage current is 0.01mA. The maximum number of drivers that can be connected in parallel to one dimming control circuit is based on this dimming lead leakage current and the calculation is described in the corresponding Design-in Guide.

Approved Dimmer List

Manufacturer	Manufacturer Part Number
Lutron	Visit www.lutron.com/advance for a list of dimmers (Mark VII) that will work with this driver
Leviton	IllumaTech IP7 series
Advance	Sunrise - SR1200ZTUNV

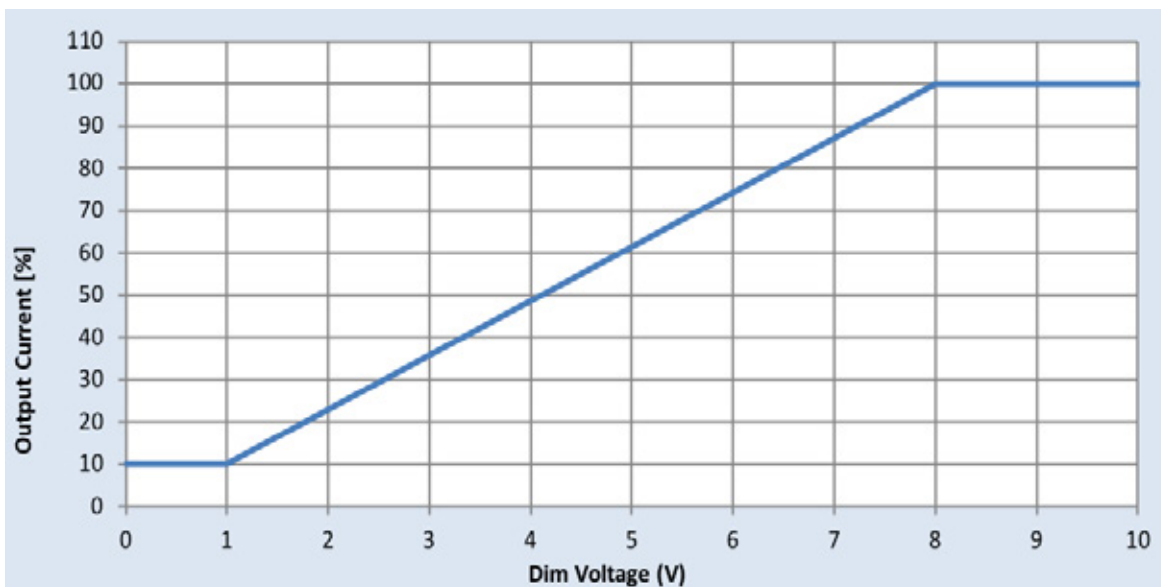

Xitanium XI030C120V040BSJ1

30W 1.2A 0-10V Dimming

Electrical Specifications

All the specifications are typical and at 25°C Tcase unless specified otherwise.

Driver Output Window

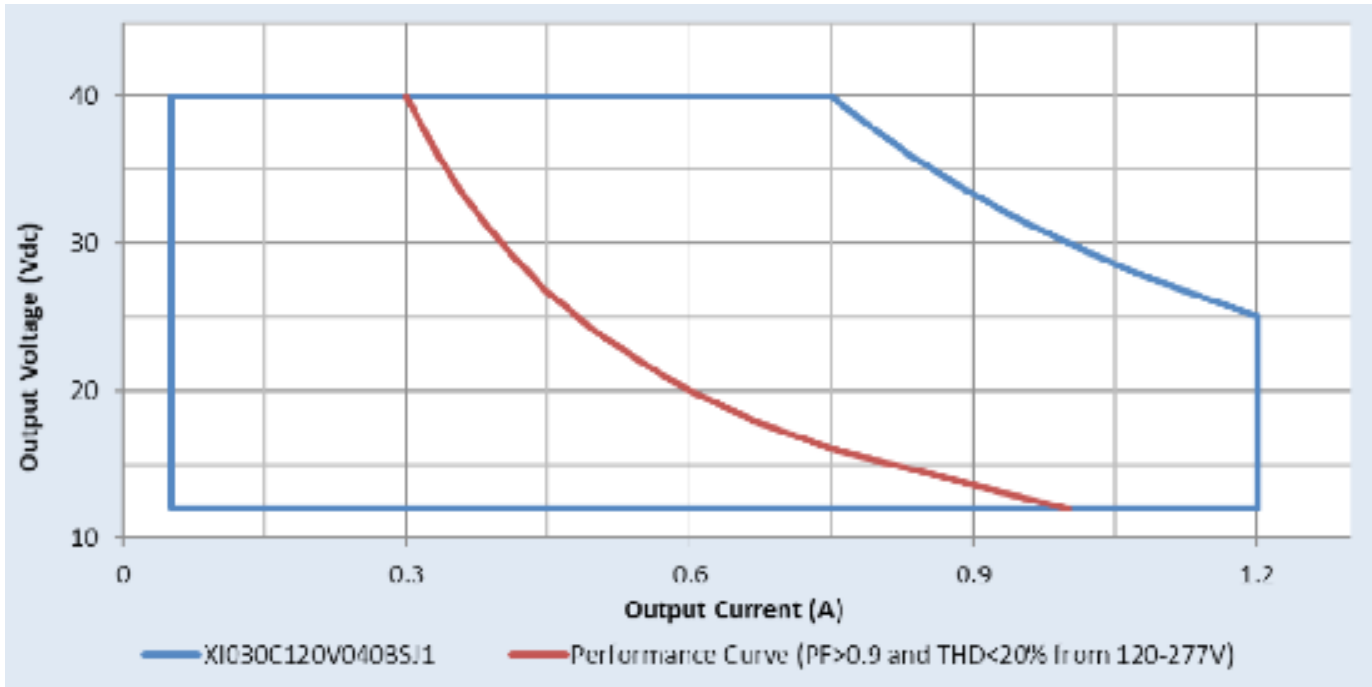

Xitanium XI030C120V040BSJ1

30W 1.2A 0-10V Dimming

Electrical Specifications

All the specifications are typical and at 25°C Tcase unless specified otherwise.

Output Current Vs. Driver Case Temperature

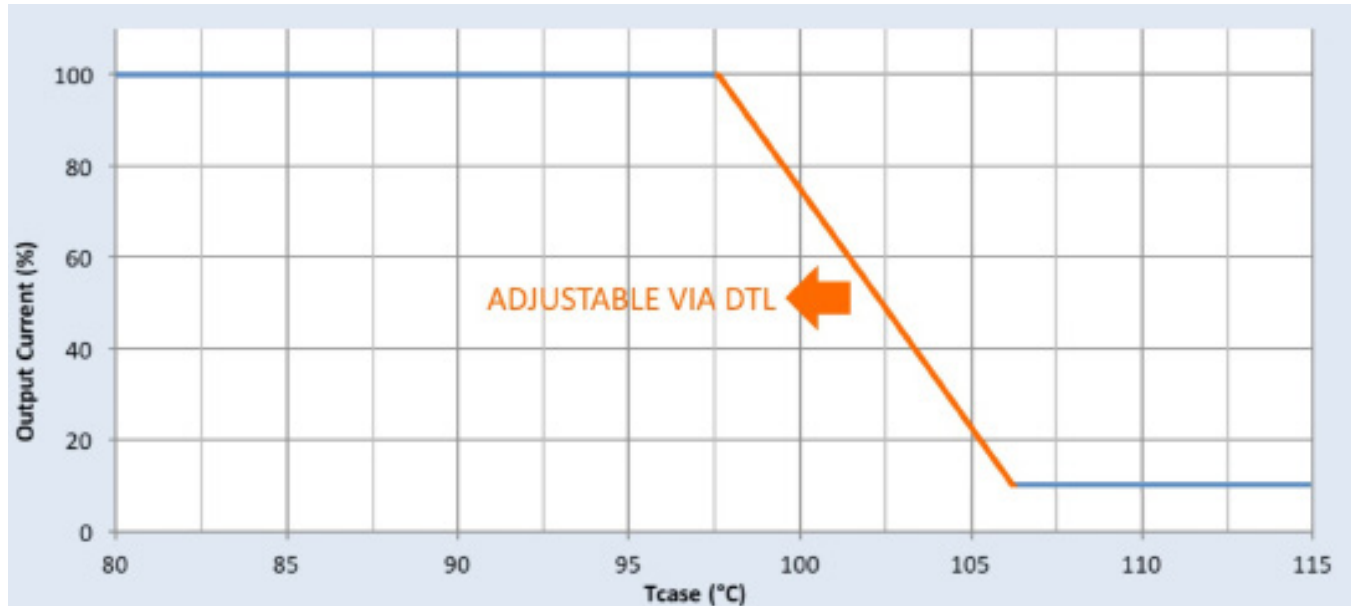

Driver Lifetime vs. Driver Case Temperature

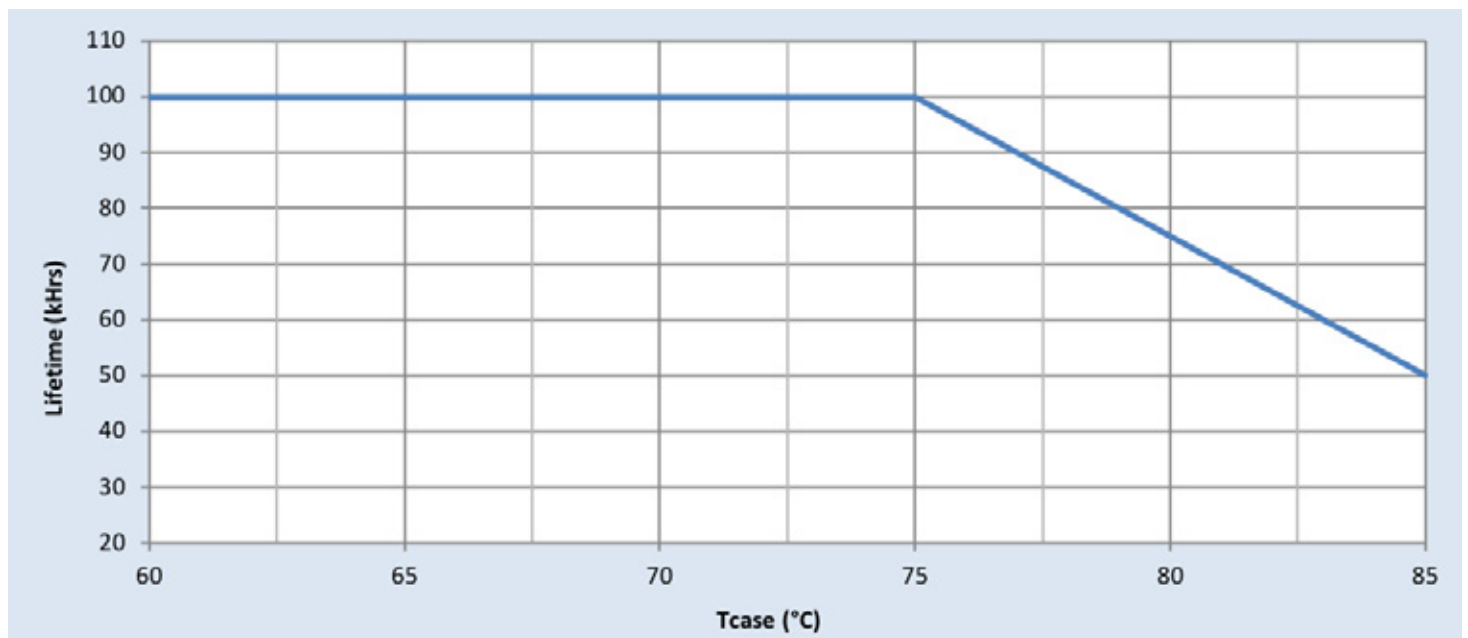

Xitanium XI030C120V040BSJ1

30W 1.2A 0-10V Dimming

Performance Characteristics

Based on measurements on a typical sample at 75°C case. The accuracy of the measurements is within the tolerance of the measurement instruments.

Efficiency Vs. Output Voltage at 120Vac

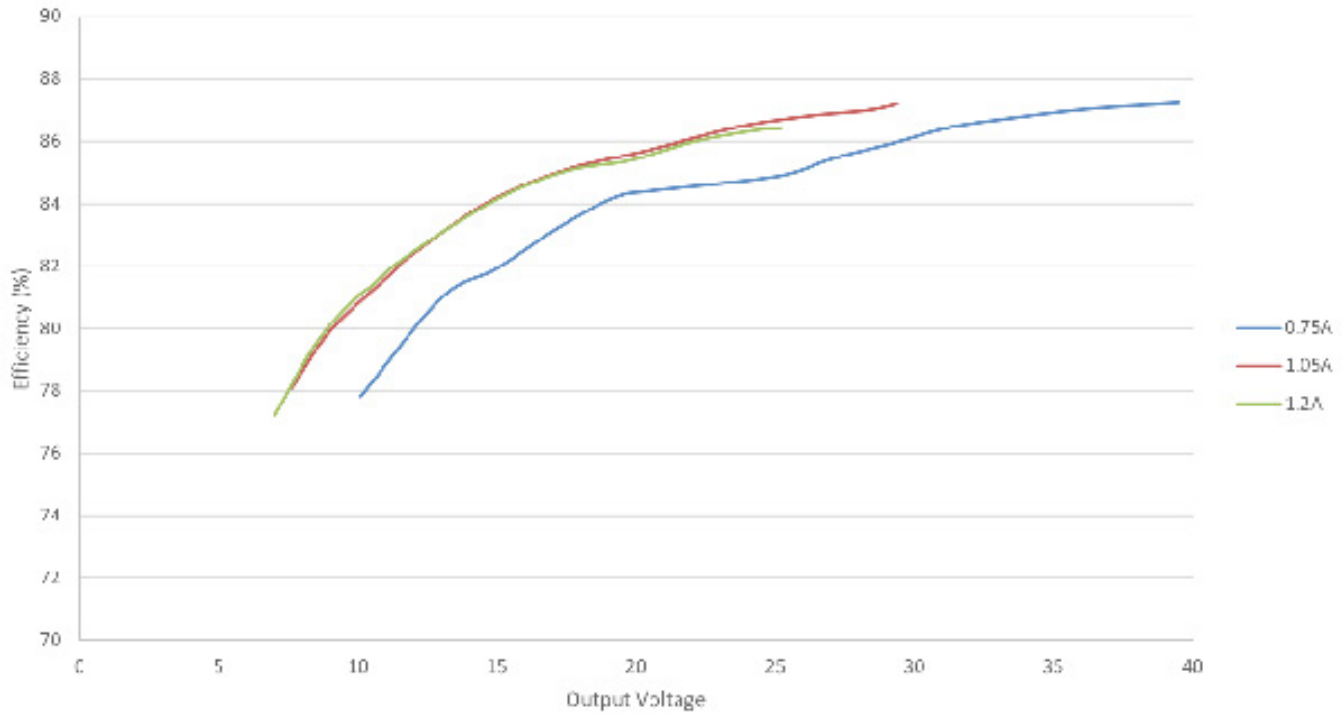

Efficiency Vs. Output Voltage at 277Vac

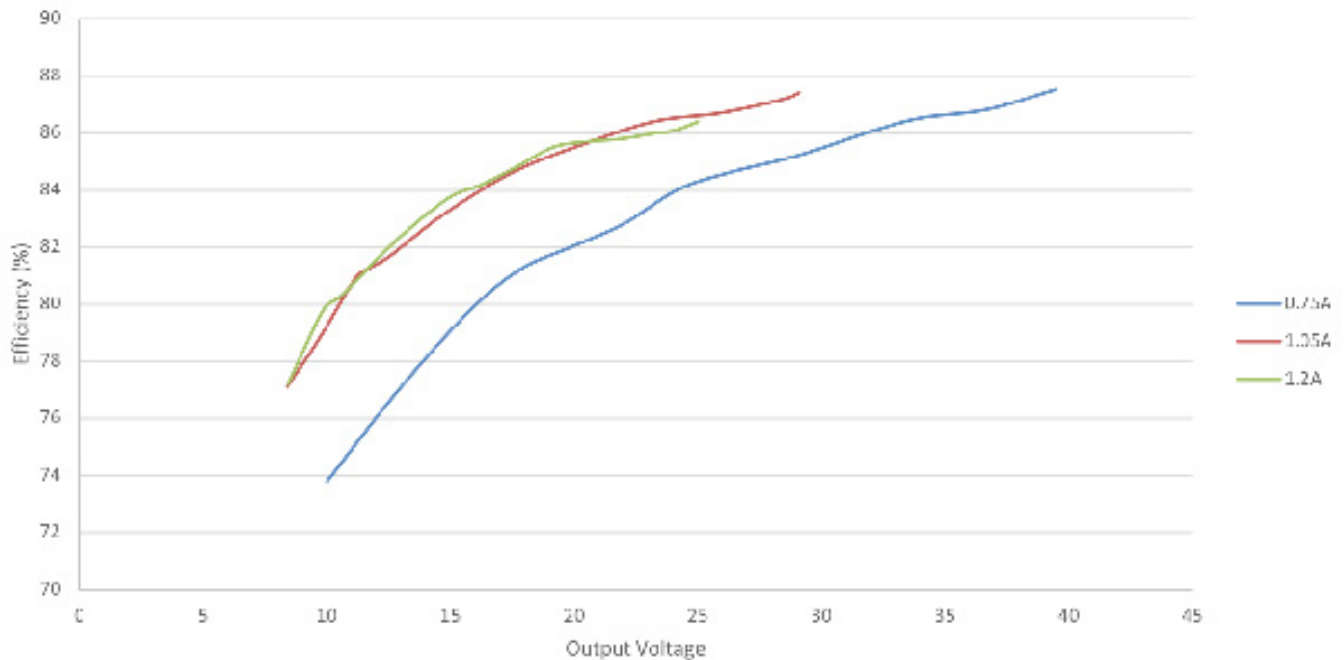

Xitanium XI030C120V040BSJ1

30W 1.2A 0-10V Dimming

Performance Characteristics

Based on measurements on a typical sample at 75°C case. The accuracy of the measurements is within the tolerance of the measurement instruments.

Power Factor Vs. Output Power

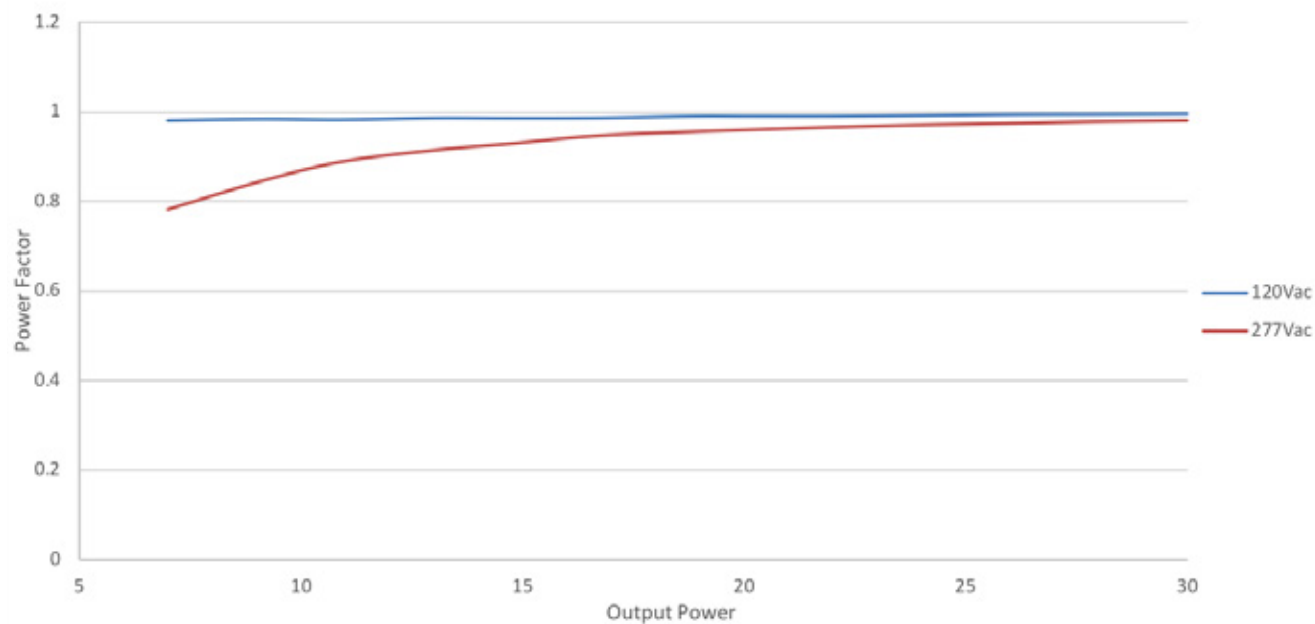

Total Harmonic Distortion (THD) Vs. Output Power

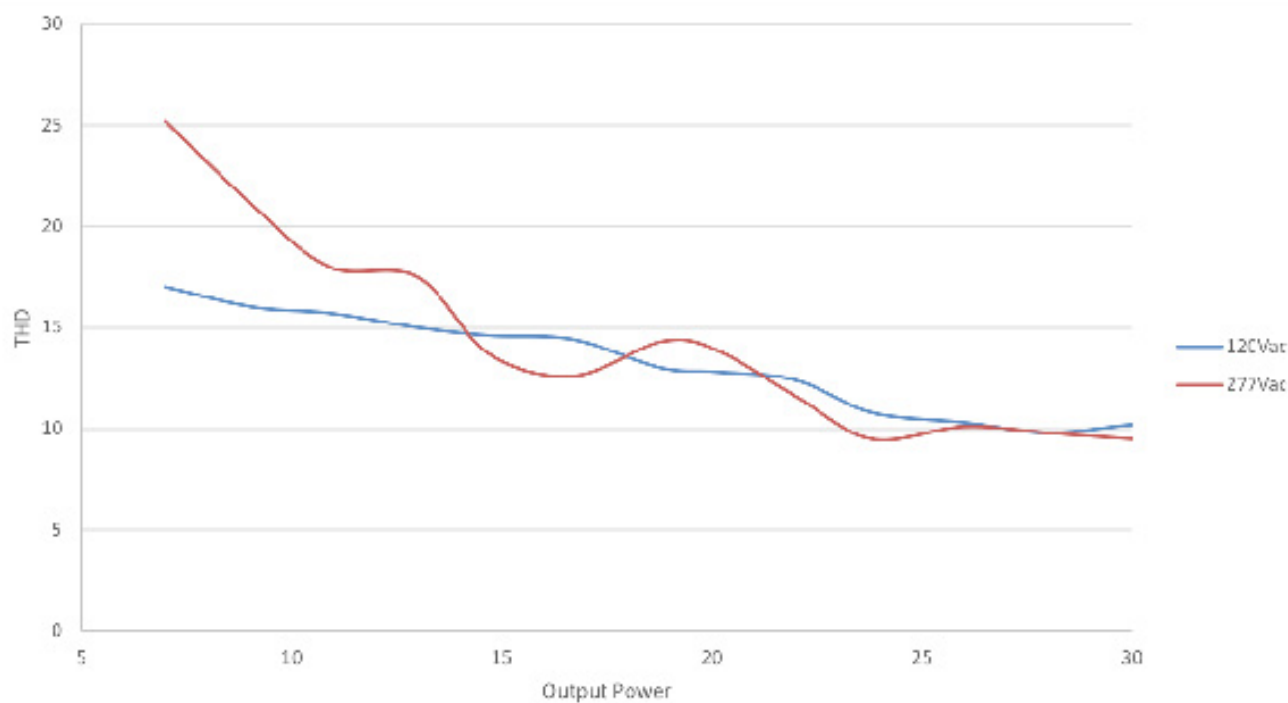

Xitanium XI030C120V040BSJ1

30W 1.2A 0-10V Dimming

Inrush Current Info

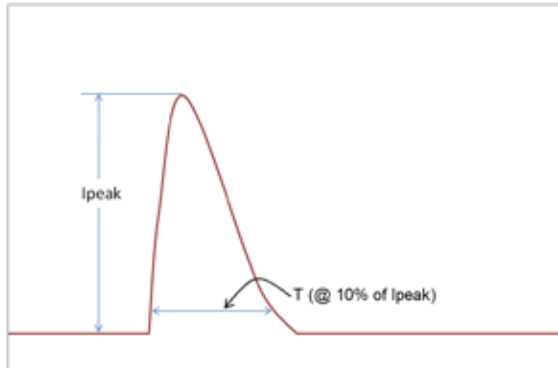

Vin	Ipeak	T (@ 10% of Ipeak)
120 Vrms	14 A	150 μs
277 Vrms	37 A	400 μs

Inrush current is measured at peak of the corresponding line voltage. Source impedance per NEMA 410.

Lightning Surge Info

ANSI Surge Type	Differential Mode (L-N)	Common Mode (L-G, N-G, L&N-G)
1.2/50μs Combination Wave (w/t 2Ω)	6kV	6kV

Isolation

Isolation	Input	Output	0-10V	Enclosure
Input	NA	2xU+1kV	2.5kV	2xU+1kV
Output	2xU+1kV	NA	2.5kV	2xU+1kV
0-10V	2.5kV	2.5kV	NA	2.5kV
Enclosure	2xU+1kV	2xU+1kV	2.5kV	NA

U = Max. input voltage



© 2022 Signify Holding. All rights reserved. The information provided herein is subject to change, without notice. Signify does not give any representation or warranty as to the accuracy or completeness of the information included herein and shall not be liable for any action in reliance thereon. The information presented in this document is not intended as any commercial offer and does not form part of any quotation or contract, unless otherwise agreed by Signify.

Signify North America Corporation
400 Crossing Blvd, Suite 600
Bridgewater, NJ 08807
Telephone: 855-486-2216

Signify Canada Ltd.
281 Hillmount Road,
Markham, ON, Canada L6C 2S3
Telephone: 800-668-9008

All trademarks are owned by Signify Holding or their respective owners.