

Project		Catalog #		Type	
Prepared by		Notes		Date	



HALO

ML56 | 1200 Series

5" and 6" LED Module
1200 lumens

Typical Applications
Residential, Light Commercial

Interactive Menu

- Order Information [page 2](#)
- Product Specifications [page 5](#)
- Energy & Performance Data [page 7](#)
- Photometric Data [page 8](#)
- Product Warranty

Product Certification



Refer to ENERGY STAR® Certified Products List.
Can be used to comply with California Title 24 High Efficacy requirements.
Certified to California Appliance Efficiency Database under JAB.

Product Features



Top Product Features

- For use with 590 series and 690 series trims
- For use with 5" and 6" Halo new construction and remodel housings
- 120-277V Input
- Compatible with select phase cut and 0-10V dimmers
- Air-tite per ASTM E283

Dimensional and Mounting Details

120V - phase cut dimming

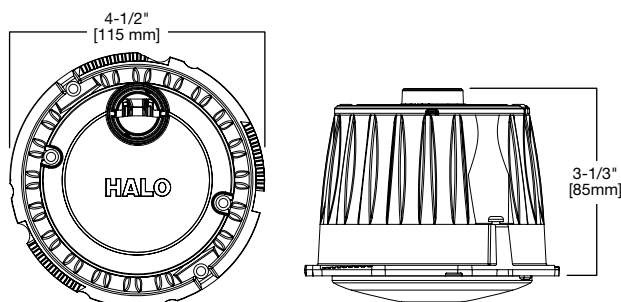

120-277V - 0-10V dimming

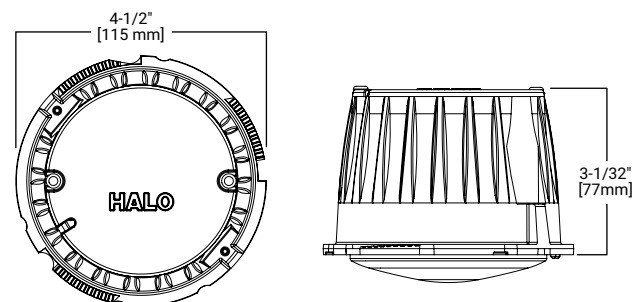

Order Information

SAMPLE ORDER NUMBER: **ML5612930 593WB**

Order LED Module and trim separately.

A complete system also includes a compatible housing (new construction, remodel, or existing retrofit). Housing aperture size in the ML56 System is determined by the ML56 trim dimensions. ML56 trims are available in 5" and 6" aperture (5" = 59xx series and 6" = 69xx series trims). Refer to Housing Section in this document.

ML56 LED Modules 1200 Series 90 CRI	Driver Option	ML56 LED 5" and 6" Trims	ML56 Beam Forming Optic/Media 1200 Series Accessories	ML56 System Accessories
<p>ML5612927= 5"/6" LED module, 1200 lumen, 90CRI, 2700K ML5612930= 5"/6" LED module, 1200 lumen, 90CRI, 3000K ML5612935= 5"/6" LED module, 1200 lumen, 90CRI, 3500K ML5612940= 5"/6" LED module, 1200 lumen, 90CRI, 4000K ML5612D2W930= 5"/6" dim-to-warm LED module, 1200 lumen, 90CRI, 1850K</p> <p>California non-E26 modules⁽¹⁾ ML5612927-CA = 5/6" LED module, 1200 lumen, 90CRI, 2700K, California non-E26 ML5612930-CA = 5/6" LED module, 1200 lumen, 90CRI, 3000K, California non-E26 ML5612935-CA = 5/6" LED module, 1200 lumen, 90CRI, 3500K, California non-E26 ML5612940-CA = 5/6" LED module, 1200 lumen, 90CRI, 4000K, California non-E26</p>	<p>[Blank] = 120V 50-60Hz, Leading Edge and Trailing Edge control 5% dimming D010 = UNV 120-277V 50-60Hz, 0-10V analog 5% dimming⁽²⁾</p>	<p>590 Series - 5" LED Trims 592SC=5" LED trim, specular reflector & white flange 592H=5" LED trim, haze reflector & white flange 592W=5" LED trim, white reflector & flange 593WB=5" LED trim, white micro-step baffle & flange 593BB=5" LED trim, black micro-step baffle & white flange 594WB=5" LED directional trim, white eyeball, baffle & flange – shallow and standard housings 595WW=5" LED trim, wall wash - specular reflector, repositionable specular kick reflector, white flange 596WB=5" LED trim, white shallow baffle & flange – shallow and standard housings</p> <p>690 Series - 6" LED Trims 692SC=6" LED trim, specular reflector & white flange 692H=6" LED trim, haze reflector & white flange 692W=6" LED trim, white reflector & flange 693WB=6" LED trim, white micro-step baffle & flange 693BB=6" LED trim, black micro-step baffle & white flange 693TBZB=6" LED trim, tuscan bronze micro-step baffle & flange 693SNB=6" LED trim, satin nickel micro-step baffle & satin nickel flange 694WB=6" LED directional trim, white eyeball, baffle & flange – shallow and standard housings 694TBZB=6" LED directional trim, tuscan bronze eyeball, baffle & flange – shallow and standard housings 694SNB=6" LED directional trim, satin nickel eyeball, baffle & flange – shallow and standard housings 695WW=6" LED trim, wall wash - specular reflector, repositionable specular kick reflector, white flange 696WB=6" LED trim, white shallow baffle & flange – for use with shallow and standard housings</p>	<p>BFR56NFL=Beam forming reflector kit, narrow flood, 25° nominal BFR56MH=Media holder, accepts one 3.45" lens. (Requires BFR56NFL & L345SF, order separately.) L345SF=3.45" diameter soft focus lens. Requires (BFR56NFL and BFR56MH, order separately.)</p>	<p>ML7RAB=Retrofit adapter band for housings without torsion spring receivers. The ML7RAB kit supplies parts to retrofit four housings; the kit includes: 4 – Retrofit adapter bands with screws and locking wire nuts WW595SC=5" Wall wash insert - kick reflector for 595WW (1-included with trim) double or corner wall wash** WW695SC=6" Wall wash insert - kick reflector for 695WW (1-included with trim) double or corner wall wash** TRM590WH=5" LED oversize trim ring for use with 59" series trims, white 6.3" I.D., 7.5" O.D. Ring slips over LED trim. Inset design allows 5" trim to fit into oversize ring for an even trim surface TRM690WH=6" LED oversize trim ring for use with 69" series trims, white 6.9" I.D., 9.5" O.D. Ring slips over LED trim. Inset design allows 6" trim to fit into oversize ring for an even trim surface</p> <p>**Wall Wash Trims 595WW and 695WW Feature an exclusive Repositionable Kick Reflector for fine-tuning adjustment of the wall wash effect. The WW595SC and WW695SC are Repositionable Kick Reflectors sold separately for addition to the Wall Wash Trim when a double or corner wall wash is needed, or for replacement of original kick reflector included with the trim.</p>
<p>Notes (1) California product only.</p>	<p>(2) Not compatible with ML5612D2W930 dim-to-warm or -CA California LED modules</p>	<p>Notes</p>	<p>Notes</p>	<p>Notes</p>

Housing – Compatibility

The ML56 LED module - trim combination is cULus Listed or UL Classified for use with any 5" or 6" diameter recessed housing constructed of steel or aluminum with an internal volume that exceeds 115 in³ in addition to those noted below.

Halo UL Listed Compatibility

D010 Housings	
<p>5" Trims: 591X, 592X, 593X, 594X, 595X, 596X</p> <p>Halo LED 5-inch H550ICATD010 = 5" LED, Insulated Ceiling, Air-Tite, New Construction Housing, 120-277V, 0-10V dimming H550RICATD010 = 5" LED, Insulated Ceiling, Air-Tite, Remodel Housing, 120-277V, 0-10V dimming</p> <p>Halo LED Fire Rated 6-inch H550FR2ICATD010 = 6" fire safe new construction housing for LED integrated trims or modules, 120-277V, 0-10V dimming</p>	<p>6" Trims: 691X, 692X, 693X, 694X, 695X, 696X</p> <p>Halo LED 6-inch H750ICATD010 = 6" LED, Insulated Ceiling, Air-Tite, New Construction Housing, 120-277V, 0-10V dimming H750RICATD010 = 6" LED, Insulated Ceiling, Air-Tite, Remodel Housing, 120-277V, 0-10V dimming</p> <p>Halo LED Fire Rated 6-inch H750FR2ICATD010 = 6" fire safe new construction housing for LED integrated trims or modules, 120-277V, 0-10V dimming</p>
<p>Notes</p>	

Housing – Compatibility (continued)

The ML56 LED module - trim combination is cULus Listed or UL Classified for use with any 5" or 6" diameter recessed housing constructed of steel or aluminum with an internal volume that exceeds 115 in³ in addition to those noted below.

Halo UL Listed Compatibility

E26 Housings

E26 Housings	
<p>5-inch Trims: 591X, 592X, 593X, 594X, 595X, 596X (Note 5-inch shallow housings for use with 591X, 594X, 596X trims only)</p> <p>Halo LED 5-inch H550ICAT = 5" LED, Insulated Ceiling, Air-Tite, New Construction Housing H550RICAT = 5" LED, Insulated Ceiling, Air-Tite, Remodel Housing E550ICAT = 5" LED, Insulated Ceiling, Air-Tite, New Construction Housing E550RICAT = 5" LED, Insulated Ceiling, Air-Tite, Remodel Housing</p> <p>Halo Shallow Housings 5-inch H25ICAT = 5" Shallow, Insulated Ceiling, Air-Tite New Construction H25RICAT = 5" Shallow, Insulated Ceiling, Air-Tite Remodel H25ICATNB = 5" Shallow, Insulated Ceiling, Air-Tite New Construction, No Socket Bracket</p> <p>Halo Standard Housings 5-inch H5ICAT = 5" Insulated Ceiling, Air-Tite New Construction Housing H5RICAT = 5" Insulated Ceiling, Air-Tite Remodel Housing H5ICATNB = 5" Insulated Ceiling, Air-Tite New Construction Housing, No Socket Bracket H5T = 5" Non-IC, New Construction Housing H5RT = 5" Non-IC, Remodel Housing H5TNB = 5" Non-IC, New Construction Housing, No Socket Bracket E5ICAT = 5" Insulated Ceiling, Air-Tite New Construction Housing E5RICAT = 5" Insulated Ceiling, Air-Tite Remodel Housing E5ICATNB = 5" Insulated Ceiling, Air-Tite New Construction Housing, No Socket Bracket ESTAT = 5" Non-IC, New Construction Housing E5RTAT = 5" Non-IC, Remodel Housing E5TATNB = 5" Non-IC, New Construction Housing, No Socket Bracket</p>	<p>6-inch Trims: 691X, 692X, 693X, 694X, 695X, 696X (Note 6-inch shallow housings for use with 691X, 694X, 696X trims only)</p> <p>Halo LED 6-inch H750ICAT = 6" LED, Insulated Ceiling, Air-Tite, New Construction Housing H750RICAT = 6" LED, Insulated Ceiling, Air-Tite, Remodel Housing H750T = 6" LED, Non-IC, Air-Tite, New Construction Housing H750TCP = 6" LED, Non-IC, New Construction/Remodel Chicago Plenum Housing H2750ICAT = 6" LED, Shallow, Insulated Ceiling, Air-Tite, New Construction (use with 691X, 694X, 696X trims only) H2750RICAT = 6" LED, Shallow, Insulated Ceiling, Air-Tite, Remodel (use with 691X, 694X, 696X trims only) E750ICAT = 6" LED, Insulated Ceiling, Air-Tite, New Construction Housing E750RICAT = 6" LED, Insulated Ceiling, Air-Tite, Remodel Housing</p> <p>Halo LED Fire Rated 6-inch H750FR2ICAT = 6" fire safe new construction housing for LED integrated trims or modules</p> <p>Halo LED retrofit ML7E26RFX = 6" Retrofit Enclosure, Non-IC, E26 Screw base Interface ML7BFX = 6" Retrofit Enclosure, Non-IC, BX Whip</p> <p>Halo Shallow Housings 6-inch H27ICAT = 6" Shallow, Insulated Ceiling, Air-Tite New Construction H27RICAT = 6" Shallow, Insulated Ceiling, Air-Tite Remodel Housing H27T = 6" Shallow, Non-IC, New Construction Housing H27RT = 6" Shallow, Non-IC, Remodel Housing E27ICAT = 6" Shallow, Insulated Ceiling, Air-Tite New Construction E27RICAT = 6" Shallow, Insulated Ceiling, Air-Tite Remodel Housing E27TAT = 6" Shallow, Non-IC, New Construction Housing E27RTAT = 6" Shallow, Non-IC, Remodel Housing</p> <p>Halo Standard Housings 6-inch H7ICAT = 6" Insulated Ceiling, Air-Tite New Construction Housing H7RICAT = 6" Insulated Ceiling, Air-Tite Remodel Housing H7ICT = 6" Insulated Ceiling, New Construction Housing H7RICT = 6" Insulated Ceiling, Remodel Housing H7ICATNB = 6" Insulated Ceiling, Air-Tite New Construction Housing, No Socket Bracket H7ICTNB = 6" Insulated Ceiling, New Construction Housing, No Socket Bracket H7T = 6" Non-IC, New Construction Housing H7RT = 6" Non-IC, Remodel Housing H7TNB = 6" Non-IC, New Construction Housing, No Socket Bracket H7TCP = 6" Non-IC, Chicago Plenum, New Construction/Remodel Housing H7UICAT = 6" Insulated Ceiling, Universal, Air-Tite, New Construction Housing E7ICAT = 6" Insulated Ceiling, Air-Tite New Construction Housing E7RICAT = 6" Insulated Ceiling, Air-Tite Remodel Housing E7ICATNB = 6" Insulated Ceiling, Air-Tite New Construction Housing, No Socket Bracket E7TAT = 6" Non-IC, New Construction Housing E7RTAT = 6" Non-IC, Remodel Housing E7TATNB = 6" Non-IC, New Construction Housing, No Socket Bracket</p>
<p>Notes</p>	

Housings – UL Classified for Retrofit Compatibility

6" Trims: 692X, 693X, 694X, 695X, 696X

Juno	IC22, IC22R, IC22W, IC22S, IC23, IC23W, TC2, TC2R, IC2	Thomas	PS1
Capri	CR1, PR1, QL1	Commercial Electric	C7ICA, H3
Elco	HL7ICA (EL7ICA)	Progress	P87-AT †
Lithonia	LC6, L7X	Lightolier	1104ICx †, 1104IC †

† Requires ML7RAB retrofit adapter band (ordered separately); for use in housings without torsion springs.

Juno®, Capri, Lightolier®, Lithonia Lighting®, Thomas® Lighting, Elco Lighting®, Progress® Lighting and Commercial Electric™ and their product brand names, where identified above, are trade names or trademarks of each respective company and Cooper makes no representations on these trademarks.

Housing – Trim Compatibility

Housing compatibility in the ML56 System is determined by the ML56 trim dimensions.

ML56 trims are available in 5-inch and 6-inch aperture (5-inch = 59xx series and 6-inch = 69xx series trims).

(Note: "xx" in the trim model number denotes finish code.)

5-inch Trims

591 5" "dead front" shallow baffle



591WB
white "dead front" shallow baffle
(for 600 Series module only)

592 5" reflector



592W
white



592SC
specular clear

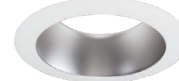

592H
haze

593 5" baffle



593WB
white baffle and trim

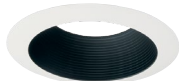

593BB
black baffle, white trim

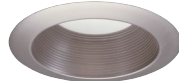

593SN
satin nickel baffle and trim

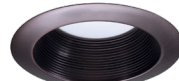

593TBZ
tuscan bronze baffle and trim

594 5" eyeball



594WB
white



594SN
satin nickel



594TBZ
tuscan bronze

595 5" wall wash



595WW
specular reflector

596 5" shallow baffle



596WB
white shallow baffle and trim

6-inch Trims

691 6" "dead front" shallow baffle



691WB
white "dead front" shallow baffle
(for 600 Series module only)

692 6" reflector



692W
white



692SC
specular clear



692H
haze

693 6" baffle



693WB
white baffle and trim

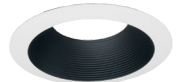

693BB
black baffle, white trim

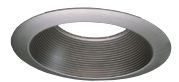

693SN
satin nickel baffle and trim



693TBZ
tuscan bronze baffle and trim

694 6" eyeball



694WB
white



694SN
satin nickel



694TBZ
tuscan bronze

695 6" wall wash



695WW
specular reflector

696 6" shallow baffle



696WB
white shallow baffle and trim

Product Specifications

Mechanical

Light Module

- Module includes LED package, LED driver, heat sink, and lens
- Durable die-cast aluminum construction.
- Heat sink designed to conduct heat away from the LED keeping the junction temperatures below specified maximums, including insulated ceiling environments

Optics

- Diffuse lens is standard on all 1200 Series LED light modules
- Impact-resistant polycarbonate
- Convex form for lamp-like appearance
- High lumen transmission
- Optional beam forming optic replaces diffuse lens and provide narrow flood (NFL) 25° nominal distribution. Beam forming optic is field installed. Order separately (accessories).

Mounting

- Modules attach to reflector and baffle trims via locking tabs, and attach to eyeballs via keyed twist-to-lock mating bosses
- The complete light module and trim assembly installs into housings with precision formed torsion springs located on the trim
- Use the retrofit adapter band (ML7RAB) accessory when housing does not have receivers for torsion springs.

Housing Compatibility

- A complete ML56 system includes a LED Module, LED trim, and a compatible housing (new construction, remodel, or existing retrofit).
- Housing compatibility in the ML56 System is determined by the ML56 trim dimensions.
- ML56 trims are available in 5" and 6" aperture (5" = 59xx series and 6" = 69xx series trims). Refer to Housing – Trim Section in this document.

LED

- 1200 Series = 1200 design lumens typical. Delivered lumens vary upon 5" or 6" trim, color temperature, and trim finish.
- Color Temperature options: 2700K, 3000K, 3500K, 4000K
- CRI: 90, R9750
- L70 at 50,000 hours, projected in accordance with IES TM-21
- LED is a chip on board design consisting of a multiple LED package with proximity phosphor coating to create one virtual white light source for a productive "cone of light"

Color Specification & Quality Standards

- A tight chromaticity specification ensures LED color uniformity, sustainable Color Rendering Index (CRI) and Correlated Color Temperature (CCT) over the useful life of the LED
- LED color uniformity of 3 SDCM, exceeds ENERGY STAR® color standards per ANSI C78.377-2008.
- High color performance with 90CRI minimum, and R9 greater than 50.
- Every Halo LED Module is quality tested and performance measured, and then serialized in a permanent record to register lumens, wattage, CRI and CCT.
- Halo LED serialized testing and measurement process ensures color and lumen consistency on a per-unit basis, and validates long-term product consistency over time
- Halo ML56 LED Modules include lumen, CRI, and CCT designations in the model number Example: ML5612930
 - 56 = 5" / 6" aperture series
 - 12 = 1200 lumen series
 - 9 = >90 CRI
 - 30 = 3000K nominal CCT

Electrical Power Connections

- LED connector is a non-screw base luminaire disconnect offering easy installation in Halo 5" H550 series and 6" H750 and 2750 series housings (per LED trim 5" or 6").
- LED Connector meets high-efficacy luminaire requirements for a non-screw base, and where required.
- The included E26 medium screw-base Edison adapter* provides easy retrofit of incandescent housings (non-California product only) (see Housing Section).

Ground Connection

- Separate grounding cable included on the module for attachment to the housing during installation.

LED Driver

- Driver is universal voltage 120V-277V, and may be controlled from a switch in Halo LED housings at 120V, 220V, 230V, 240V, and 277V.
- Two driver options:
 - (1) Dimmable at 120V operation when connected to a compatible phase cut dimmer.
 - (2) Dimmable at 120-277V operation when connected to a compatible 0-10V dimmer.
- Driver is a high efficiency, electronic power supply providing DC power to the LED.
- Driver meets FCC EMI/RFI Consumer Level limits on 120-277V main inputs, and is compliant for use in residential and commercial installations.
- Driver features high power factor, low THD, and has integral thermal protection in the event of over temperature or internal failure.
- Driver is replaceable, if replacement should be required.

Dimming

- Designed for dimming capability to nominal 5% in normal operation with standard 120V Leading Edge (LE) and Trailing Edge (TE) phase control dimmers or 120-277V 0-10V dimmers (Consult dimmer manufacturer for dimmer compatibility and details. Note, some dimmers require a neutral in the wall box).

Compliance

- cULus listed 1598 Luminaire (Halo housings)
- UL Classified when used in retrofit (refer to housing section)
- cULus listed for damp locations
- cULus Wet location listed with baffle and reflector trims only
- Airtight certified per ASTM E283 (not exceeding 2.0 CFM under 57 Pascals pressure difference)
- IP56 ingress protection rated with baffle and reflector trims only
- RoHS compliant
- May be used in IC (insulated ceiling) housings in direct contact with insulation* and combustible material
- Can be used for California Title 24 compliance
- Can be used for International Energy Conservation Code (IECC) high efficiency luminaire compliance.
- Can be used for Washington State Energy Code compliance
- ENERGY STAR® certified luminaire - consult ENERGY STAR® certified product list
- EMI/RFI per FCC 47CFR Part 15 Class B Consumer limits (commercial and residential compliant)
- Photometric testing in accordance with IES LM-79
- Lumen maintenance projections in accordance with IES LM-80 and TM-21
- CE Mark - "Conformité Européene" conformity with the Council of European Communities Directives, meeting internationally recognized compliance when used with Halo H550, H750, and H2750 Series LED housings only

Warranty

- Five year limited warranty, consult website for details. www.cooperlighting.com/legal

LED Module in New or Retrofit Existing Construction – Housings other than Halo

- If used in recessed housings other than Halo, the Cooper Lighting Solutions 5-year limited warranty applies to the LED Module and Trim only.
- As with any electrical installation, a qualified electrician must ensure compatibility of use with a particular housing; this includes all applicable national and local electrical and building codes. Installer is responsible to properly and securely retain the LED Module and LED Trim in the housing at time of installation.

ML56 1200 Series Compliance Table

90 CRI LED Modules with ML56 Trims

	ML5612927	ML5612930	ML5612935	ML5612940
593BB	WSEC, IECC	WSEC, IECC	ES, T24, WSEC, IECC	ES, T24, WSEC, IECC
693BB	ES, T24, WSEC, IECC	ES, T24, WSEC, IECC	ES, T24, WSEC, IECC	ES, T24, WSEC, IECC
593TBZB	ES, T24, WSEC, IECC	ES, T24, WSEC, IECC	ES, T24, WSEC, IECC	ES, T24, WSEC, IECC
693TBZB	ES, T24, WSEC, IECC	ES, T24, WSEC, IECC	ES, T24, WSEC, IECC	ES, T24, WSEC, IECC
593SNB	ES, T24, WSEC, IECC	ES, T24, WSEC, IECC	ES, T24, WSEC, IECC	ES, T24, WSEC, IECC
693SNB	ES, T24, WSEC, IECC	ES, T24, WSEC, IECC	ES, T24, WSEC, IECC	ES, T24, WSEC, IECC
592H	ES, T24, WSEC, IECC	ES, T24, WSEC, IECC	ES, T24, WSEC, IECC	ES, T24, WSEC, IECC
593WB	ES, T24, WSEC, IECC	ES, T24, WSEC, IECC	ES, T24, WSEC, IECC	ES, T24, WSEC, IECC
592SC	ES, T24, WSEC, IECC	ES, T24, WSEC, IECC	ES, T24, WSEC, IECC	ES, T24, WSEC, IECC
592W	ES, T24, WSEC, IECC	ES, T24, WSEC, IECC	ES, T24, WSEC, IECC	ES, T24, WSEC, IECC
595WW	ES, T24, WSEC, IECC	ES, T24, WSEC, IECC	ES, T24, WSEC, IECC	ES, T24, WSEC, IECC
695WW	ES, T24, WSEC, IECC	ES, T24, WSEC, IECC	ES, T24, WSEC, IECC	ES, T24, WSEC, IECC
692H	ES, T24, WSEC, IECC	ES, T24, WSEC, IECC	ES, T24, WSEC, IECC	ES, T24, WSEC, IECC
692W	ES, T24, WSEC, IECC	ES, T24, WSEC, IECC	ES, T24, WSEC, IECC	ES, T24, WSEC, IECC
692SC	ES, T24, WSEC, IECC	ES, T24, WSEC, IECC	ES, T24, WSEC, IECC	ES, T24, WSEC, IECC
693WB	ES, T24, WSEC, IECC	ES, T24, WSEC, IECC	ES, T24, WSEC, IECC	ES, T24, WSEC, IECC
596WB	ES, T24, WSEC, IECC	ES, T24, WSEC, IECC	ES, T24, WSEC, IECC	ES, T24, WSEC, IECC
694TBZB	ES, T24, WSEC, IECC	ES, T24, WSEC, IECC	ES, T24, WSEC, IECC	ES, T24, WSEC, IECC
696WB	ES, T24, WSEC, IECC	ES, T24, WSEC, IECC	ES, T24, WSEC, IECC	ES, T24, WSEC, IECC
594TBZB	ES, T24, WSEC, IECC	ES, T24, WSEC, IECC	ES, T24, WSEC, IECC	ES, T24, WSEC, IECC
694SNB	ES, T24, WSEC, IECC	ES, T24, WSEC, IECC	ES, T24, WSEC, IECC	ES, T24, WSEC, IECC
594SNB	ES, T24, WSEC, IECC	ES, T24, WSEC, IECC	ES, T24, WSEC, IECC	ES, T24, WSEC, IECC
694WB	ES, T24, WSEC, IECC	ES, T24, WSEC, IECC	ES, T24, WSEC, IECC	ES, T24, WSEC, IECC
594WB	ES, T24, WSEC, IECC	ES, T24, WSEC, IECC	ES, T24, WSEC, IECC	ES, T24, WSEC, IECC
594WB-30	ES, T24, WSEC, IECC	ES, T24, WSEC, IECC	ES, T24, WSEC, IECC	ES, T24, WSEC, IECC
694WB-30	ES, T24, WSEC, IECC	ES, T24, WSEC, IECC	ES, T24, WSEC, IECC	ES, T24, WSEC, IECC

Code Descriptions:

ES = ENERGY STAR® Certified Luminaire

IECC = International Energy Conservation Code "High Efficacy"

WSEC = Washington State Energy Code - "High Efficacy" Luminaire

ML56 1200 Series Lumen Table

90 CRI LED Modules with ML56 trims

	Trim Catalog #	ML5612927		ML5612930		ML5612935		ML5612940	
		Lumens	LPW	Lumens	LPW	Lumens	LPW	Lumens	LPW
0° Tilt Angle	593BB	727.0	42.0	777.4	62.4	848.4	71.3	875.8	67.4
	693BB	813.6	47.0	870.0	69.9	949.5	79.8	980.1	75.4
	593TBZB	821.3	47.5	878.3	70.5	958.5	80.5	989.5	76.1
	693TBZB	845.7	48.9	904.4	72.6	987.0	82.9	1018.9	78.4
	593SNB	900.1	52.0	962.6	77.3	1050.5	88.3	1084.4	83.4
	693SNB	937.9	54.2	1002.9	80.6	1094.5	92.0	1129.8	86.9
	592H	1036.6	59.9	1108.6	89.0	1209.8	101.7	1248.9	96.1
	593WB	1057.7	61.1	1131.1	90.9	1234.4	103.7	1274.3	98.0
	592SC	1071.1	61.9	1145.4	92.0	1250.0	105.0	1290.3	99.3
	592W	1074.4	62.1	1148.9	92.3	1253.9	105.4	1294.3	99.6
	595WW	1077.7	62.3	1152.5	92.6	1257.7	105.7	1298.3	99.9
	695WW	1078.8	62.4	1153.7	92.7	1259.0	105.8	1299.7	100.0
	692H	1082.2	62.6	1157.2	93.0	1262.9	106.1	1303.7	100.3
	692W	1099.9	63.6	1176.2	94.5	1283.6	107.9	1325.1	101.9
	692SC	1104.4	63.8	1181.0	94.9	1288.8	108.3	1330.4	102.3
	693WB	1109.9	64.2	1186.9	95.3	1295.3	108.8	1337.1	102.9
	596WB	1113.8	64.4	1191.1	95.7	1299.8	109.2	1341.8	103.2
	694TBZB	1117.7	64.6	1195.2	96.0	1304.4	109.6	1346.5	103.6
	696WB	1137.6	65.8	1216.6	97.7	1327.7	111.6	1370.5	105.4
	594TBZB	1138.8	65.8	1217.8	97.8	1329.0	111.7	1371.9	105.5
694SNB	1149.9	66.5	1229.6	98.8	1341.9	112.8	1385.2	106.6	
594SNB	1167.6	67.5	1248.6	100.3	1362.7	114.5	1406.6	108.2	
694WB	1184.8	68.5	1267.0	101.8	1382.7	116.2	1427.4	109.8	
594WB	1192.0	68.9	1274.7	102.4	1391.2	116.9	1436.0	110.5	
30° Tilt Angle	594WB-30	1126.5	65.1	1204.7	96.8	1314.7	110.5	1357.2	104.4
	694WB-30	1108.8	64.1	1185.7	95.2	1294.0	108.7	1335.8	102.8

Photometric tests are per IES measurement standards. Tests represent typical fixture performance. Field results may vary.

Energy and Performance Data

ML56 1200/90 Series

(Values at non-dimming line voltage)

Minimum Starting Temp: -30°C (-22°F)

EMI/RFI: FCC Title 47 CFR, Part 15, (Consumer)

Sound Rating: Class A

Input Voltage: UNV 120V-277V

Power Factor: >0.95 @ 120V and >0.9 @ 277V

Input Frequency: 50/60Hz

THD: <20%

Input Power: 12.3W

Input Current at 120V: 0.14A

Input Current at 277V: 0.07A

Driver Compliance: UL8750, Class II rated

Maximum IC (Insulated Ceiling) Ambient Continuous Operating Temperature: 25°C (77°F)

Maximum Non-IC Ambient Continuous Operating Temperature: 40°C (104°F)

ML5612927

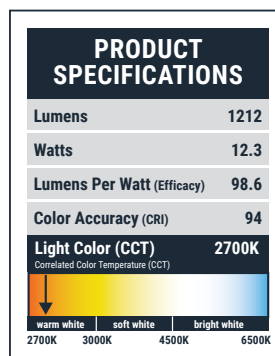

ML5612930

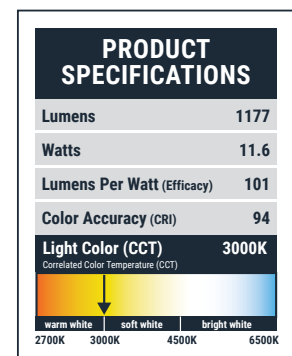

ML5612935

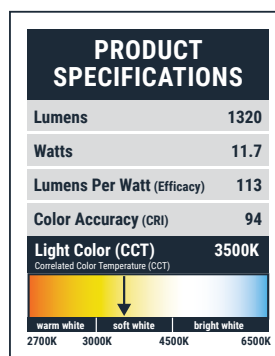

ML5612940

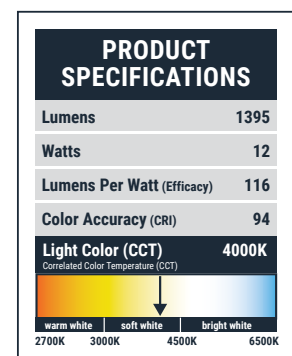

Photometry 5" Trims • 1200 Series • 90 CRI

Candlepower Distribution

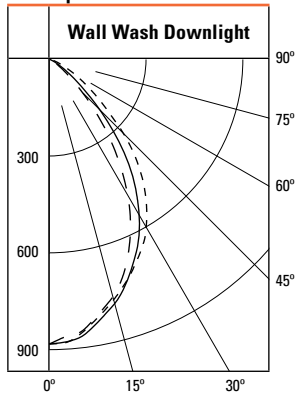

Legend

- 0-deg: --- Wall
- 90-deg: --- Side
- 180-deg: --- Room

ML5612930-595WW

Test Number	P129848
Light Module	1200 Series, 90CRI
Trim	5" Aperture, Wall Wash with Specular Clear Trim and Specular Clear Kick Reflector
Lumens	1198
Efficacy	69.6 Lm/W
SC	0.83

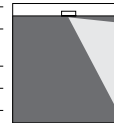

Zonal Lumen Summary

Zone	Lumens	%Fixture
0-30	590	51.5
0-40	868	75.7
0-60	1119	97.7
0-90	1146	100
90-180	0	0
0-180	1146	100

Single Unit Footcandles

2.5' From Wall (Distance From Fixture Along Wall)

DD	●	1'	2'	3'	4'	5'	6'
1'	3.9	2.6	1	0.3	0.1	0	0
2'	14.9	10.6	4.5	1.4	0.4	0.1	0
3'	18.2	14.6	7.8	3.1	1.2	0.4	0.1
4'	13.6	11.9	8.2	4.3	1.9	0.8	0.3
5'	9.3	8.4	6.6	4.3	2.4	1.2	0.5
6'	6.3	5.9	4.9	3.6	2.4	1.4	0.7
7'	4.4	4.2	3.6	2.9	2.1	1.4	0.9
8'	3.2	3	2.7	2.3	1.8	1.3	0.9
9'	2.4	2.3	2.1	1.8	1.5	1.2	0.8
10'	1.8	1.7	1.6	1.4	1.2	1	0.8

Multiple Unit Footcandles

2.5' From Wall (Distance From Fixture Along Wall)

DD	--3'--			--4'--		
1'	4.2	3.4	4.2	4	2.1	4
2'	16.3	14.4	16.3	15.3	9	15.3
3'	21.4	22.4	21.4	19.4	15.6	19.4
4'	17.9	20.1	17.9	15.5	16.4	15.5
5'	13.5	15.1	13.5	11.7	13.1	11.7
6'	9.9	10.8	9.9	8.7	9.9	8.7
7'	7.3	7.8	7.3	6.5	7.3	6.5
8'	5.4	5.7	5.4	5	5.5	5
9'	4.1	4.3	4.1	3.8	4.2	3.8
10'	3.2	3.3	3.2	3	3.2	3

Photometry 5" Trims • 1200 Series • 90 CRI • NFL Lens

Multiplier Table

CCT Option	2700 K	3000 K	3500 K	4000 K
CCT Multiplier	0.967	1.000	1.052	1.164

Table based upon testing with 3000°K color temperature, 90CRI.
Multipliers may be used to determine relative lumen values with other color temperatures.

ML5612930-BFR56NFL-594WB

Test Number	P130446
Light Module	1200 Series, 90CRI, NFL optic
Trim	5" Aperture, Directional Eyeball
Lumens	1294
Efficacy	74.8 Lm/W
SC	0.4

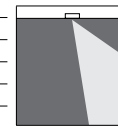

ML5612930-BFR56NFL-592H

Test Number	P130382
Light Module	1200 Series, 90CRI, NFL optic
Trim	5" Aperture, Haze Trim
Lumens	1126
Efficacy	65.1 Lm/W
SC	0.41

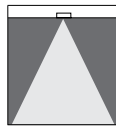

Cone of Light

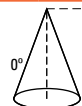

D	FC	L	W
5.5'	147.1	2.2	2.2
7'	90.8	2.8	2.8
8'	69.5	3.2	3.2
9'	54.9	3.6	3.6
10'	44.5	4	4
12'	30.9	4.8	4.8

Candlepower Distribution

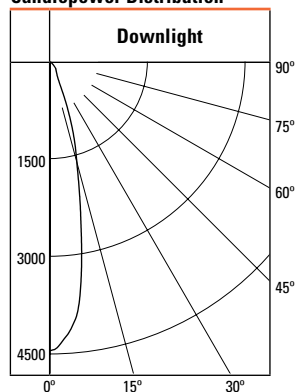

Zonal Lumen Summary

Zone	Lumens	%Fixture
0-30	982	87.2
0-40	1088	96.6
0-60	1124	99.8
0-90	1126	100
90-180	0	0
0-180	1126	100

Candlepower Distribution

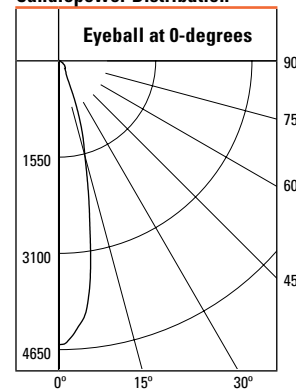

Zonal Lumen Summary

Zone	Lumens	%Fixture
0-30	984	76.1
0-40	1088	84.1
0-60	1248	96.5
0-90	1294	100
90-180	0	0
0-180	1294	100

30° Horizontal Plane

D	FC	L	W	CB
5.5'	103.5	2.8	2.4	3.2
7'	63.9	3.6	3	4
8'	48.9	4.1	3.6	4.6
9'	38.6	4.6	4	5.2
10'	31.3	5.1	4.4	5.8
12'	21.7	6.1	5.4	6.9

30° Vertical Plane

D	FC	L	W	CB
1'	836.5	1	0.6	1.7
2'	209.1	2.1	1.2	3.5
3'	92.9	3.2	1.8	5.2
4'	52.3	4.3	2.6	6.9
5'	33.5	5.4	3.2	8.7
6'	23.2	6.5	3.8	10.4

Photometric tests are per IES measurement standards. Tests represent typical fixture performance. Field results may vary.

Photometry 6" Trims • 1200 Series • 90 CRI

Multiplier Table

CCT Option	2700 K	3000 K	3500 K	4000 K
CCT Multiplier	0.9669	1.0000	1.0517	1.1644

Table based upon testing with 3000°K color temperature, 90CRI.
Multipliers may be used to determine relative lumen values with other color temperatures.

ML5612930-692SC

Test Number	P129864
Light Module	1200 Series, 90CRI
Trim	6" Aperture, Specular Clear Trim
Lumens	1174
Efficacy	67.8 Lm/W
SC	0.74

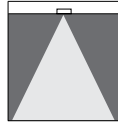

Cone of Light

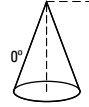

D	FC	L	W
5.5'	41.5	4	4
7'	25.6	5	5
8'	19.6	5.8	5.8
9'	15.5	6.6	6.6
10'	12.6	7.2	7.2
12'	8.7	8.8	8.8

Candlepower Distribution

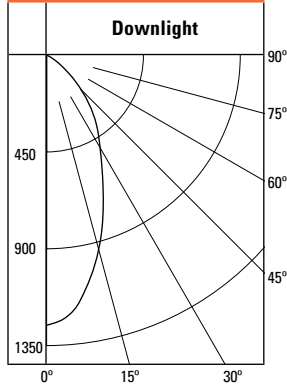

Zonal Lumen Summary

Zone	Lumens	%Fixture
0-30	655	55.8
0-40	910	77.5
0-60	1159	98.7
0-90	1174	100
90-180	0	0
0-180	1174	100

ML5612930-694WB

Test Number	P129920
Light Module	1200 Series, 90CRI
Trim	6" Aperture, Directional Eyeball
Lumens	1260
Efficacy	72.8 Lm/W
SC	1.17

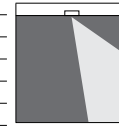

Candlepower Distribution

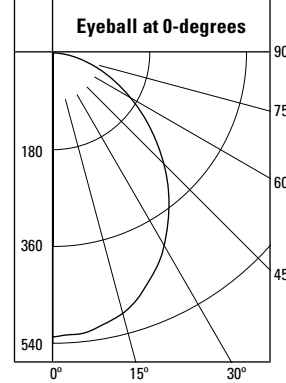

Zonal Lumen Summary

Zone	Lumens	%Fixture
0-30	397	31.5
0-40	631	50.1
0-60	1041	82.6
0-90	1260	100
90-180	0	0
0-180	1260	100

30° Horizontal Plane

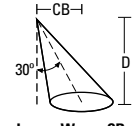

D	FC	L	W	CB
5.5'	15.1	6.3	6.4	3.2
7'	9.3	8.1	8.2	4
8'	7.1	9.2	9.4	4.6
9'	5.6	10.5	10.6	5.2
10'	4.6	11.6	11.8	5.8
12'	3.2	13.9	14.2	6.9

30° Vertical Plane

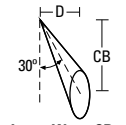

D	FC	L	W	CB
1'	279.6	1.1	1.2	1.7
2'	69.9	2.2	2.6	3.5
3'	31.1	3.5	3.8	5.2
4'	17.5	4.7	5.2	6.9
5'	11.2	5.7	6.4	8.7
6'	7.8	6.9	7.8	10.4

Candlepower Distribution

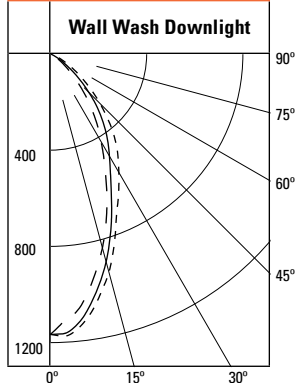

Legend

0-deg: --- Wall
90-deg: --- Side
180-deg: --- Room

ML5612930-695WW

Test Number	P129944
Light Module	1200 Series, 90CRI
Trim	6" Aperture, Wall Wash with Specular Clear Trim and Specular Clear Kick Reflector
Lumens	1147
Efficacy	66.3 Lm/W
SC	0.76

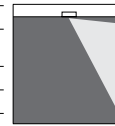

Zonal Lumen Summary

Zone	Lumens	%Fixture
0-30	625	54.5
0-40	873	76.2
0-60	1122	97.9
0-90	1147	100
90-180	0	0
0-180	1147	100

Single Unit Footcandles

2.5' From Wall (Distance From Fixture Along Wall)

DD	●	1'	2'	3'	4'	5'	6'
1'	3.2	1.9	0.7	0.2	0.1	0	0
2'	14	9.9	4.3	1.3	0.3	0.1	0
3'	16.5	13	7.2	3.1	1.2	0.4	0.1
4'	12.6	10.8	7.3	4	1.9	0.8	0.4
5'	9	8	5.9	3.9	2.3	1.2	0.6
6'	6.5	5.9	4.6	3.3	2.2	1.3	0.8
7'	4.9	4.4	3.6	2.7	1.9	1.3	0.8
8'	3.7	3.4	2.8	2.2	1.6	1.2	0.8
9'	2.8	2.6	2.2	1.8	1.4	1	0.8
10'	2.2	2.1	1.8	1.5	1.2	0.9	0.7

Multiple Unit Footcandles

2.5' From Wall (Distance From Fixture Along Wall)

DD	--3'--	--4'--
1'	3.4 2.4 3.4	3.3 1.4 3.3
2'	15.3 13.5 15.3	14.3 8.5 14.3
3'	19.6 20 19.6	17.6 14.5 17.6
4'	16.7 18.1 16.7	14.6 14.5 14.6
5'	12.9 13.9 12.9	11.3 11.8 11.3
6'	9.8 10.5 9.8	8.7 9.2 8.7
7'	7.5 8 7.5	6.8 7.1 6.8
8'	5.8 6.2 5.8	5.3 5.6 5.3
9'	4.6 4.9 4.6	4.2 4.5 4.2
10'	3.7 3.9 3.7	3.3 3.6 3.3

Photometric tests are per IES measurement standards. Tests represent typical fixture performance. Field results may vary.

Photometry 6" Trims • 1200 Series • 90 CRI • NFL Lens

Multiplier Table

CCT Option	2700 K	3000 K	3500 K	4000 K
CCT Multiplier	0.967	1.000	1.052	1.164

Table based upon testing with 3000°K color temperature, 90CRI.

Multipliers may be used to determine relative lumen values with other color temperatures.

ML5612930-BFR56NFL-692H

Test Number	P130478
Light Module	1200 Series, 90CRI, NFL optic
Trim	6" Aperture, Haze Trim
Lumens	1175
Efficacy	67.9 Lm/W
SC	0.41

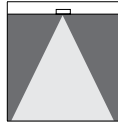

Cone of Light

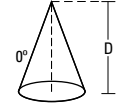

D	FC	L	W
5.5'	155.7	2.2	2.2
7'	96.1	2.8	2.8
8'	73.6	3.2	3.2
9'	58.2	3.6	3.6
10'	47.1	4	4
12'	32.7	4.8	4.8

Candlepower Distribution

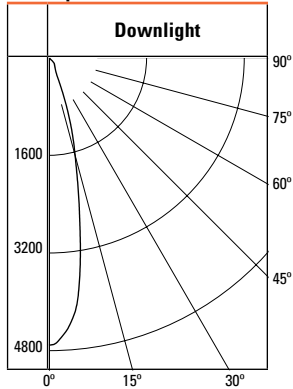

Zonal Lumen Summary

Zone	Lumens	%Fixture
0-30	1005	85.5
0-40	1110	94.4
0-60	1174	99.9
0-90	1175	100
90-180	0	0
0-180	1175	100

ML5612930-BFR56NFL-694WB

Test Number	P130542
Light Module	1200 Series, 90CRI, NFL optic
Trim	6" Aperture, Directional Eyeball
Lumens	1286
Efficacy	74.3 Lm/W
SC	0.41

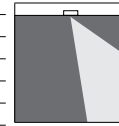

Candlepower Distribution

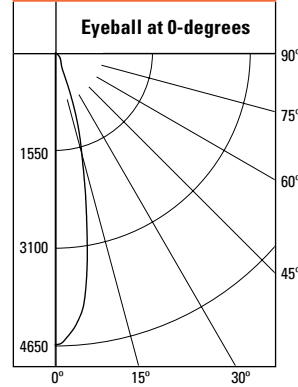

Zonal Lumen Summary

Zone	Lumens	%Fixture
0-30	1002	77.9
0-40	1109	86.2
0-60	1265	98.4
0-90	1286	100
90-180	0	0
0-180	1286	100

30° Horizontal Plane

D	FC	L	W	CB
5.5'	105.2	2.8	2.4	3.2
7'	64.9	3.6	3.2	4
8'	49.7	4.1	3.6	4.6
9'	39.3	4.7	4	5.2
10'	31.8	5.2	4.6	5.8
12'	22.1	6.2	5.4	6.9

30° Vertical Plane

D	FC	L	W	CB
1'	853.3	1	0.6	1.7
2'	213.3	2	1.2	3.5
3'	94.8	3.1	2	5.2
4'	53.3	4.2	2.6	6.9
5'	34.1	5.3	3.2	8.7
6'	23.7	6.3	4	10.4

Photometric tests are per IES measurement standards. Tests represent typical fixture performance. Field results may vary.