

Sleek, Smooth Control



Applications

Leviton SureSlide® controls provide smooth, slide-action and full-range dimming for a variety of load types. Pre-set models feature a separate ON/OFF switch, allowing the user to set the desired brightness level to operate automatically with the ON/OFF function. The 3-wire model has superior performance dimming LEDs and is a cost-effective option for new construction or renovations where a neutral wire is required or present in the wallbox. The 6672 is a slide-to-off model for users who choose to adjust lighting levels each time the device is used.

The SureSlide line offers models that are designed specifically for dimmable LED lamps, models for ELV applications, a fan speed control and a fan/light combination device.

Features and Benefits

- Integrated linear full-range slide control for easy, precise operation
- Preset versions provide single pole or 3-way lighting control when used with a 3-way switch
- Slim, compact housing fits easily into a standard wallbox and is suitable for multi-gang installations
- Built-in radio/TV interference filter

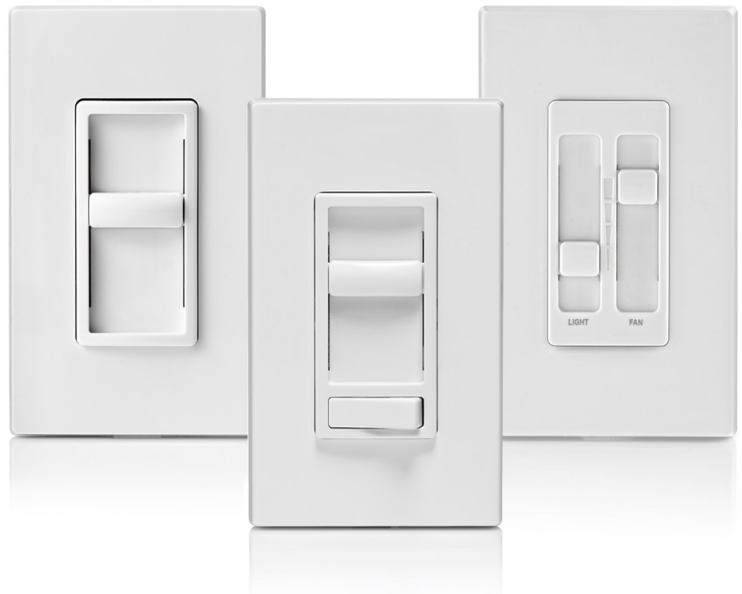

LED Dimmers

- Designed specifically for dimmable LED lamps
- Also supports dimming of incandescent, halogen and CFL lamps
- Minimum light level setting to customize the low-end dimming range of LEDs to help eliminate flicker or turning off at low light levels
- Maximum light level setting can be used to improve dimming travel and maximize energy savings
- 6674N has superior LED compatibility performance and dimming range. A neutral wire is required for installation
- 6672, 6674, 6674N and 66DF can be used to comply with California Title 24, Part 6 Indoor Lighting Switching Devices and Controls and IECC energy code requirements where required

Quiet Fan Speed Control

- Special circuitry to reduce fan motor noise at low speeds
- Quiet 1.5 amp fan speed control is perfect for libraries, home offices, bedrooms and any area where ceiling fan noise could become distracting
- Selection of low, medium or high fan speeds

Dual Quiet Fan/Light Control

- Separate controls for fan and light level selection
- Designed for use with LED/CFL and incandescent lamps
- Minimum adjustment dial to modify the dimming range
- Special circuitry to reduce fan motor noise at low speeds
- Selection of low, medium or high fan speeds

Typical Specifications

Operating Temperature Range: 0°C to 55°C

Storage Temperature Range: -10°C to 85°C

Relative Humidity: 20% to 90% non-condensing

Specifications At-A-Glance

	6672	6674	6674N	66EV	66DF	661F
Voltage, Frequency						
120VAC-60Hz	Yes	Yes	Yes	Yes	Yes	Yes
Load Rating						
Incandescent/Halogen	600W	600W	300W	-	300W	-
LED/CFL	150W	150W	150W	-	150W	-
ELV	-	-	-	300W	-	-
Motor	-	-	-	-	1.5A	1.5A
Mechanical						
Neutral Required	No	No	Yes	Yes	No	No
Single Pole/3-Way	No	Yes	Yes	Yes	No	Yes
Locator Light	Yes, Optional	No	No	No	No	No
Installation Type						
New Construction or Retrofit	Retrofit	Retrofit	Both	Both	Both	Both

Maximum Load For Multi-Gang Applications

In multi-gang applications de-rating may be required in accordance with the following chart.

Cat. No.	Single	2-gang	3-gang or more
6674 6672	150W LED/CFL 600W Incandescent/Halogen	150W LED/CFL 500W Incandescent/Halogen	150W LED/CFL 400W Incandescent/Halogen
6674N	150W LED/CFL 300W Incandescent/Halogen	150W LED/CFL 300W Incandescent/Halogen	150W LED/CFL 300W Incandescent/Halogen
66EV	300W ELV	300W ELV	250W ELV
66DF	150W LED/CFL 300W Incandescent/Halogen - 1.5A	150W LED/CFL 300W Incandescent/Halogen - 1.5A	150W LED/CFL 250W Incandescent/Halogen - 1.5A
661F	1.5A	1.5A	1.5A

Agency Standards and Compliance

UL 1472 Solid State Dimming Controls

CSA 22.2 No. 184.1

UL 1917 Fan Control

NEMA SSL 7A Compliant (6672, 6674, 6674N and 66DF only)

California Title 24 Compliant (6672, 6674, 6674N only)

IECC Compliant (all dimmers)

Warranty Information

Five-Year Limited Warranty

Installation Considerations

6672, 6674, 6674N and 66DF: LED lamps marked or rated as dimmable can be used with this dimmer. For a complete list of approved LED lamps visit www.leviton.com/led.

Mode Selector Switch



- Options to optimize performance for LED lamps for best performance (factory preset to Mode A)

- Switch also enables the programming mode to adjust maximum and minimum light levels

- 6674N has a control timing setting that can be used to help improve dimming performance if the lights pulse at certain dimming levels or when fading on or off

Dimensional Drawings

Cat. No. 6672, 6674, 6674N (shown), 66EV, 661F

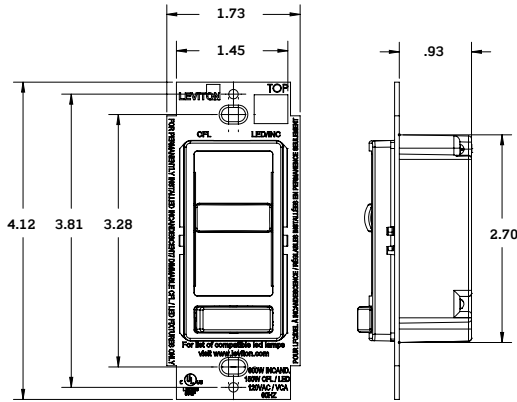

Cat. No. 66DF

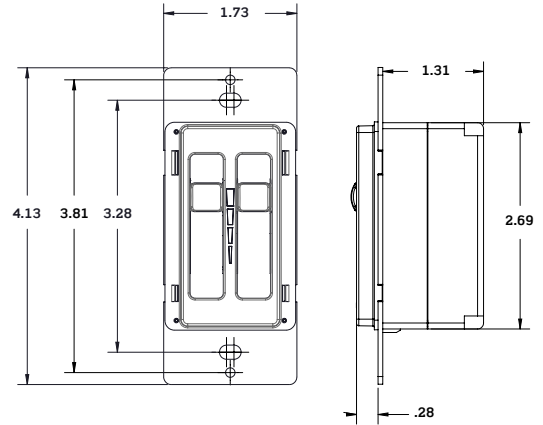

Wiring Diagrams

Cat. No. 6674, 661F

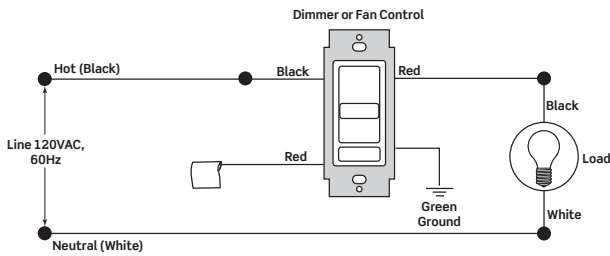

Single Pole

Cat. No. 6674N

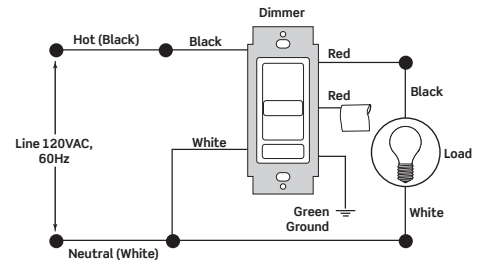

Single Pole

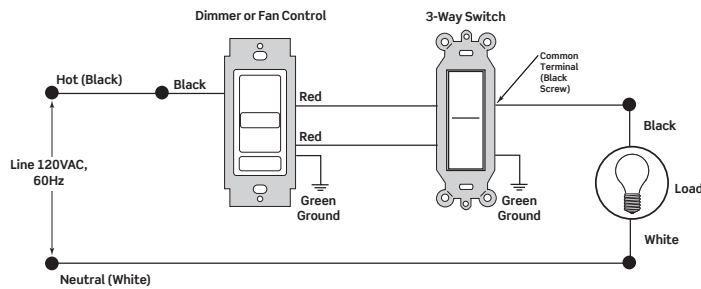

3-Way (Line Side)

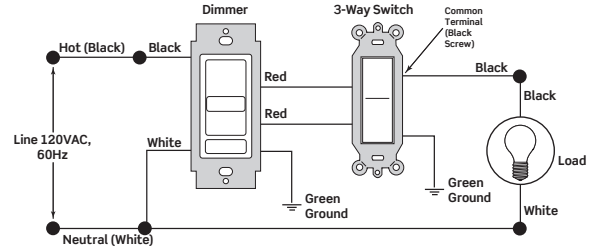

3-Way (Line Side)

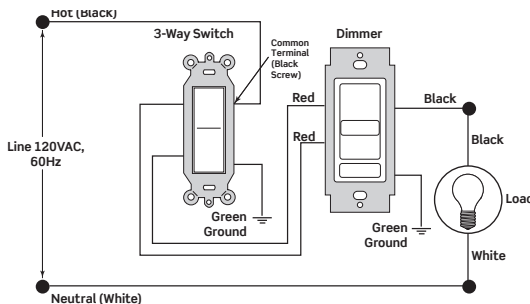

3-Way (Load Side)

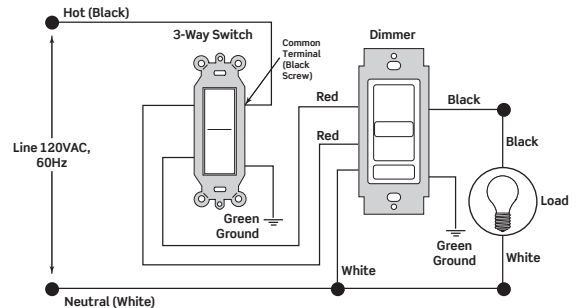

3-Way (Load Side)

Wiring Diagrams

Cat. No. 66EV

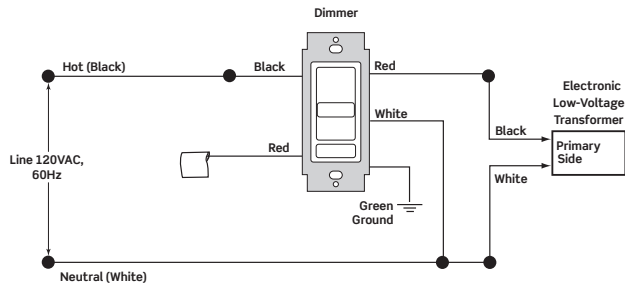

Single Pole

Cat. No. 6672

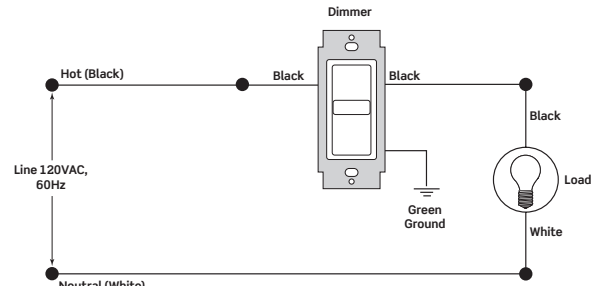

Single Pole

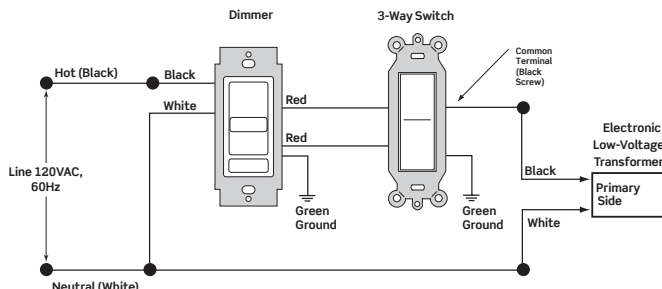

3-Way (Line Side)

Cat. No. 66DF

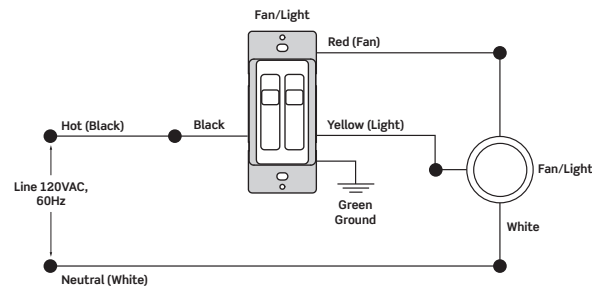

Single Pole

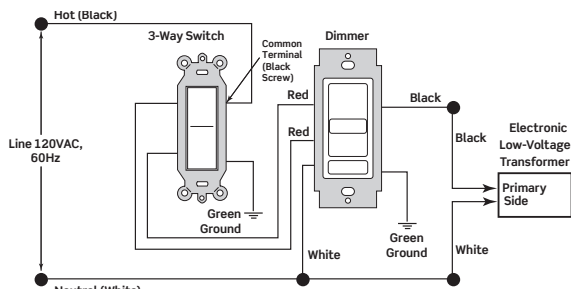

3-Way (Load Side)

Ordering Information

Description	Cat. No.	Rating	Color*
LED/CFL/Incandescent Dimmer, Slide-to-OFF, Single Pole	6672-1L	150W LED/CFL 600W Incandescent/Halogen	W, I, T
LED/CFL/Incandescent Dimmer with pre-set ON/OFF switch, Single Pole or 3-way	6674-P0	150W LED/CFL 600W Incandescent/Halogen	W, I, T, E, B
	6674-10		W
LED/CFL/Incandescent Dimmer with pre-set ON/OFF switch, Single Pole or 3-way, neutral wire	6674N-10	150W LED/CFL 300W Incandescent/Halogen	W
Electronic Low Voltage Dimmer with pre-set ON/OFF switch, Single Pole or 3-way, neutral wire	66EV-10	300W ELV	W, I, T
Dual Quiet Fan/Light Control, Slide-to-OFF, Single Pole	66DF-10	150W LED/CFL 300W Incandescent/Halogen 1.5A Motor	W, I, T
Quiet Fan Speed Control, 3-speed with pre-set ON/OFF switch, Single Pole or 3-way	661F-10	1.5A Motor	W, I, T

*To order colors, add suffix to basic catalog number: White (-W), Ivory (-I), Light Almond (-T), Black (-E) and Brown (-B).



Leviton Manufacturing Co., Inc.

Tech Line: 1-800-824-3005

Mon-Fri 8am-10pm EST, Saturday 9am-7pm EST, Sunday 9am-5pm EST

For 24/7 product support visit www.leviton.com/support

Visit our Website at: www.leviton.com/dimmers

© 2024 Leviton Manufacturing Co., Inc. All rights reserved. All trademarks are the property of their respective owners.

