

CUSTOMER NAME _____
 PROJECT NAME _____
 DATE _____ TYPE _____
 CATALOG NUMBER _____

EFH1 Series

High Output LED Flood Light Mounting & Accessories

The Evolve® LED High Output Flood Light is our high-lumen solution to efficiently illuminate building facade, flag poles, billboard signage and many more traditional flood applications. Designed to replace 250W-400W HPS and 400W-1000W Metal Halide Flood Lights.



Construction

Housing:	Aluminum die cast enclosure. Integral heat sink for maximum heat transfer
Lens:	Impact resistant tempered glass
Paint:	Corrosion resistant polyester powder paint, minimum 2.0 mil thickness Standard = Black, Dark Bronze, Gray, White (RAL & custom colors available) Optional = Coastal Finish
Weight:	35 lbs (15.9 kgs)

Optical system

Lumens:	23,400 - 59,000
Distribution:	3x3, 6x5, 6x6, 7x6, 7x7
Efficacy:	121 -164 LPW
CCT:	2700K, 3000K, 4000K, 5000K
CRI:	≥70

Electrical

Input Voltage:	120-277V, 277-480V
Input Frequency:	50/60 Hz
Power Factor:	≥ 90% at rated watts
Total Harmonic Distortion:	≤ 20% at rated watts

Surge Protection*

Typical	Enhanced	Extreme
<input type="checkbox"/> 6kV/3kA*	<input type="checkbox"/> 10kV/5kA*	<input type="checkbox"/> 20kV/10kA*

*Per ANSI C136.2-2015

Warranty

- 5 Year (Standard) 10 Year (Optional)

Lumen Maintenance

Projected Lxx per IES TM-21-11 at 25°C

Lumen Codes	Distribution	LXX(10K) @ Hours		
		25,000 HR	50,000 HR	60,000 HR
30, 35, 40, 45, 50	77, 76, 67, 66, 65	L97	L94	L93
30, 35, 40, 45, 50	33	L96	L94	L94
55	77, 76, 66, 65	L96	L92	L91
60	77, 76, 66	L96	L92	L90

Note: Projected LXX based on LM80 (> 10,000 hour testing). Accepted Industry tolerances apply to initial luminous flux and lumen maintenance measurements.

Luminaire Ambient Temperature Factor

Ambient Temp (°C)	Initial Flux Factor	Ambient Temp (°C)	Initial Flux Factor
10	1.02	30	0.99
20	1.01	40	0.98
25	1.00	50	0.97

Ratings

Operating Temperature:	-40° C to 50° C
Vibration^:	2G - Slipfitter Mounting K1, K2, S1 & S2 3G - Trunnion Mounting T1
LM-79:	Testing in accordance with IESNA Standards

^Per ANSI C136.31-2010

Controls

Dimming:	Standard - 0-10V <input type="checkbox"/> Optional - DALI (Option U) <input type="checkbox"/>
Sensors:	Photo Electric Sensors (PE) available LightGrid and Daintree Compatible



Visit www.designlights.org/search to confirm qualifications.

Ordering Information

EFH1 02

7

PROD. ID	GEN	VOLTAGE	LUMENS	DISTRIBUTION	CRI	CCT	DIMMING	CONTROLS	MOUNTING	COLOR	OPTIONS
E=Evolve	02	0 = 120-277V ¹	30 = 30,000 lm	33 = NEMA 3x3	7 = 70	27 = 2700K	A = ANSI C136.41 7-Pin Receptacle ⁴	A = No Control	K1 = Knuckle slipfitter 1.9 in. - 2.3 in OD Tenon ⁶	GRAY = Gray	F = Fusing ¹
FH= Flood High		1 = 120V	35 = 35,000 lm	65 = NEMA 6x5		30 = 3000K	D = No receptacle, with external dimming 18/2 3 ft cable	D = Shorting Cap ⁵	K2 = Knuckle slipfitter 1.9 in. - 2.3 in OD Tenon Supplied with 14/3 3ft power cable	BLCK = Black	H2 = Daintree Enabled ⁷ motion Sensor ^{7,8}
1= Standard		2 = 208V	40 = 40,000 lm	66 = NEMA 6x6		40 = 4000K	N = No PE Receptacle & Non Dimmable	E = ANSI C136.41 7-pin with non-Dimming PE Control ⁵	S1 = Knuckle slipfitter 2.3-3.0 in. OD Tenon ⁸	DKBZ = Dark Bronze	H4 = Motion Sensor (FSP221) ⁸
		3 = 240V	45 = 45,000 lm	76 = NEMA 7x6		50 = 5000K	P = ANSI C136.41 7-Pin Receptacle with external dimming 18/2 3 ft cable ⁴		S2 = Knuckle slipfitter 2.3-3.0 in. OD Tenon, Supplied with 14/3 3ft power cable	WHITE = White	NOM = NOM31 ¹¹
		4 = 277V	50 = 50,000 lm	77 = NEMA 7x7					T1 = Trunnion with external 3ft #14/3 power cable		P06 = Prewired with 6ft #14/3 cable
		5 = 480V	55 = 55,000 lm ^{2,3}						V1 = Knuckle Wall Mount ⁹		R = 10kV/5kA Enhanced Surge Protection Device (SPD)
		D = 347V	60 = 60,000 lm ^{2,3}								T = 20kV/10kA Enhanced Surge Protection Device (SPD)
		E = 277-480V ¹									U = DALI Dimming ⁹
											V0 = 3-Position Terminal Block
											V1 = FAM module
											Y = Coastal Finish ¹⁰

NOTES

- ¹ Fusing requires discrete voltage
- ² Not Available in 3x3 distribution
- ³ Not Available in 6x5 distribution
- ⁴ Restricted aiming angle of 0-45°
- ⁵ Can only be ordered with "A" or "P" Dimming Options
- ⁶ Supplied with leads
- ⁷ Not available in 347V, 480V OR 277-480V
- ⁸ Only available in K1 or S1 mount
- ⁹ Compatible with LightGrid System
- ¹⁰ Recommended for installations within 750 feet from coast. Lead time varies, check with factory
- ¹¹ Contact Manufacturer

EFH1 Series

High Output LED Flood Light
Mounting & Accessories

CUSTOMER NAME _____

PROJECT NAME _____

DATE _____ TYPE _____

CATALOG NUMBER _____

LUMEN OUTPUT	DIST CODE	CLASSIFICATION (HXV)	TYPICAL INITIAL LUMENS				SYSTEM WATTAGE
			2700K	3000K	4000K	5000K	
30	77	7x7	27000	29100	30000	30000	183
35			31500	33900	35000	35000	213
40			36000	38800	40000	40000	248
45			40500	43600	45000	45000	285
50			45000	48500	50000	50000	323
55			49500	53300	53500	53500	356
60			53100	57200	59000	59000	366
30	76	7x6	27000	29100	30000	30000	183
35			31500	33900	35000	35000	213
40			36000	38800	40000	40000	248
45			40500	43600	45000	45000	285
50			45000	48500	50000	50000	323
55			49500	53300	55000	55000	356
60			53100	57200	59000	59000	366
30	66	6x6	27000	29100	30000	30000	183
35			31500	33900	35000	35000	213
40			36000	38800	40000	40000	248
45			40500	43600	45000	45000	285
50			45000	48500	50000	50000	323
55			49500	53300	55000	55000	356
60			53100	57200	59000	59000	366
30	65	6x5	23400	25300	26100	26100	183
35			27300	29400	30400	30400	213
40			31300	33700	34800	34800	248
45			35100	37900	39100	39100	285
50			39100	42100	43500	43500	323
30	33	3x3	26500	27300	28500	28500	193
35			32500	33600	35000	35000	246
40			37200	38400	40000	40000	285
45			41800	43200	45000	45000	325
50			46500	48000	50000	50000	365

For additional information on Shielded and Non-Shielded EFH IES files, please refer to LED.com

EFH1 Series

High Output LED Flood Light
Mounting & Accessories

CUSTOMER NAME _____

PROJECT NAME _____

DATE _____ TYPE _____

CATALOG NUMBER _____

EFH1
NEMA 7x7

59,000 Lumens
4000K
EFH102_6077740_.....IES

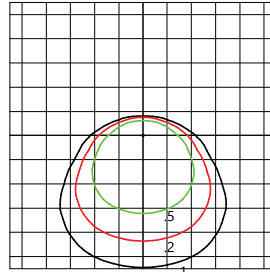

- Mounting Height at 35°
- 45° Tilt Initial Footcandle at Grade

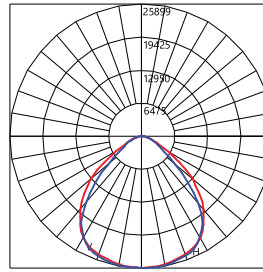

- Vertical Axial Candela Distribution
- Horizontal Axial Candela Distribution

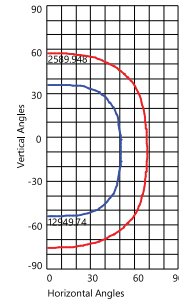

EFH1
NEMA 7x6

59,000 Lumens
4000K
EFH102_6076740_.....IES

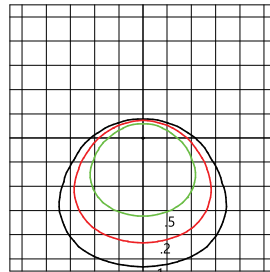

- Mounting Height at 35°
- 45° Tilt Initial Footcandle at Grade

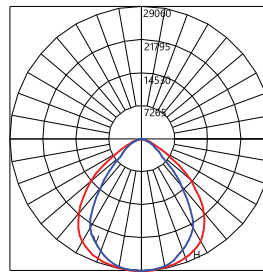

- Vertical Axial Candela Distribution
- Horizontal Axial Candela Distribution

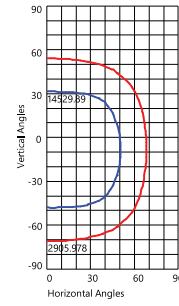

EFH1
NEMA 6x6

59,000 Lumens
4000K
EFH102_6066740_.....IES

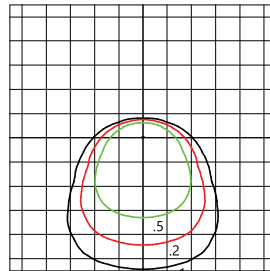

- Mounting Height at 35°
- 45° Tilt Initial Footcandle at Grade

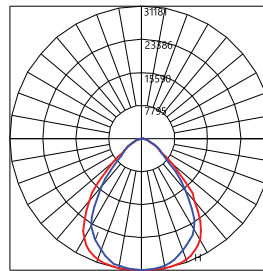

- Vertical Axial Candela Distribution
- Horizontal Axial Candela Distribution

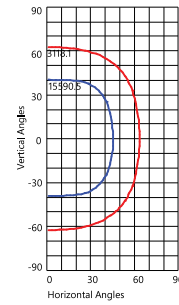

EFH1
NEMA 6x5

43,500 Lumens
4000K
EFH102_5065740_.....IES

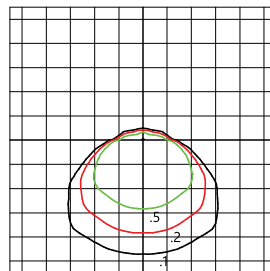

- Mounting Height at 35°
- 45° Tilt Initial Footcandle at Grade

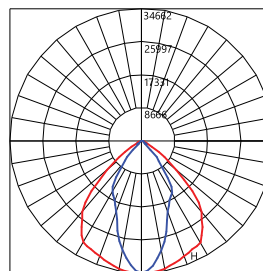

- Vertical Axial Candela Distribution
- Horizontal Axial Candela Distribution

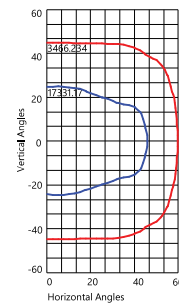

EFH1
NEMA 3x3

50,000 Lumens
4000K
EFH102_5033740_.....IES

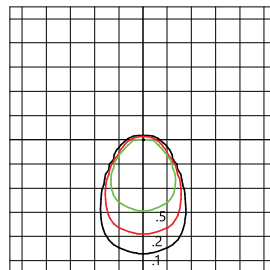

- Mounting Height at 35°
- 45° Tilt Initial Footcandle at Grade

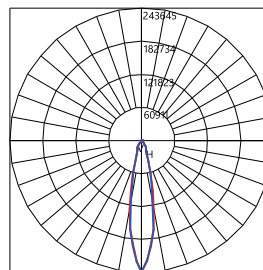

- Vertical Axial Candela Distribution
- Horizontal Axial Candela Distribution

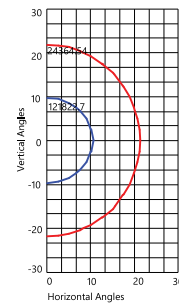

EFH1 Series

High Output LED Flood Light
Mounting & Accessories

CUSTOMER NAME _____

PROJECT NAME _____

DATE _____ TYPE _____

CATALOG NUMBER _____

H4 Motion Sensing Option

Recommended Mounting Height:	15-30' (4.6-9.1m)
Coverage Radius:	15-30' (4.6-6.1 m)
Lateral Coverage:	300 °
Power:	Adds < 1W to fixture power rating
Default Settings:	
Output:	Occupied - 100% Unoccupied - 10%
PE Sensor:	None
Ramp/Fade:	Disabled
Time (Off) Delay:	5 min.
Field:	Programmable using FSIR-100 hand held programmer (197634)

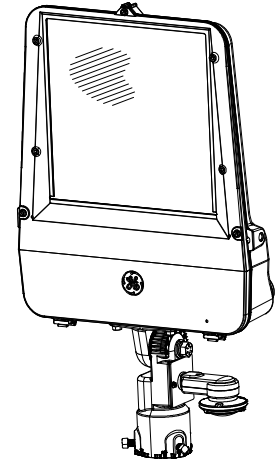
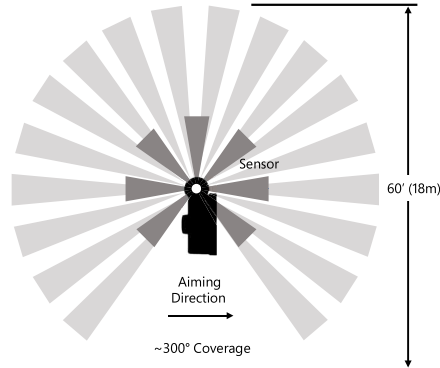

H2 - Daintree Enabled Motion Sensing Option

Recommended Mounting Height:	15-30' (4.6-9.1m)
Coverage Radius:	15-30' (4.6-6.1 m)
Lateral Coverage:	300 °
Power:	Adds < 1W to fixture power rating
Default Settings:	
Output:	Occupied - 100% Unoccupied - 10%
PE Sensor:	None
Ramp/Fade:	Disabled
Time (Off) Delay:	10 min.
Requires Wireless Area Controller (WAC)	

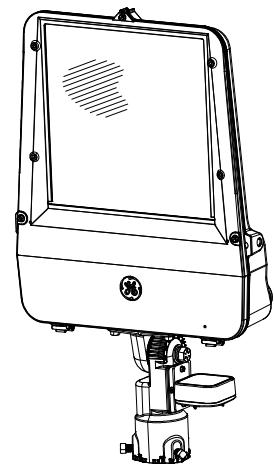
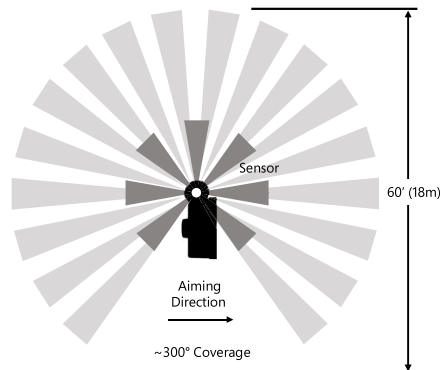

EFH1 Series

High Output LED Flood Light
Mounting & Accessories

CUSTOMER NAME _____

PROJECT NAME _____

DATE _____ TYPE _____

CATALOG NUMBER _____

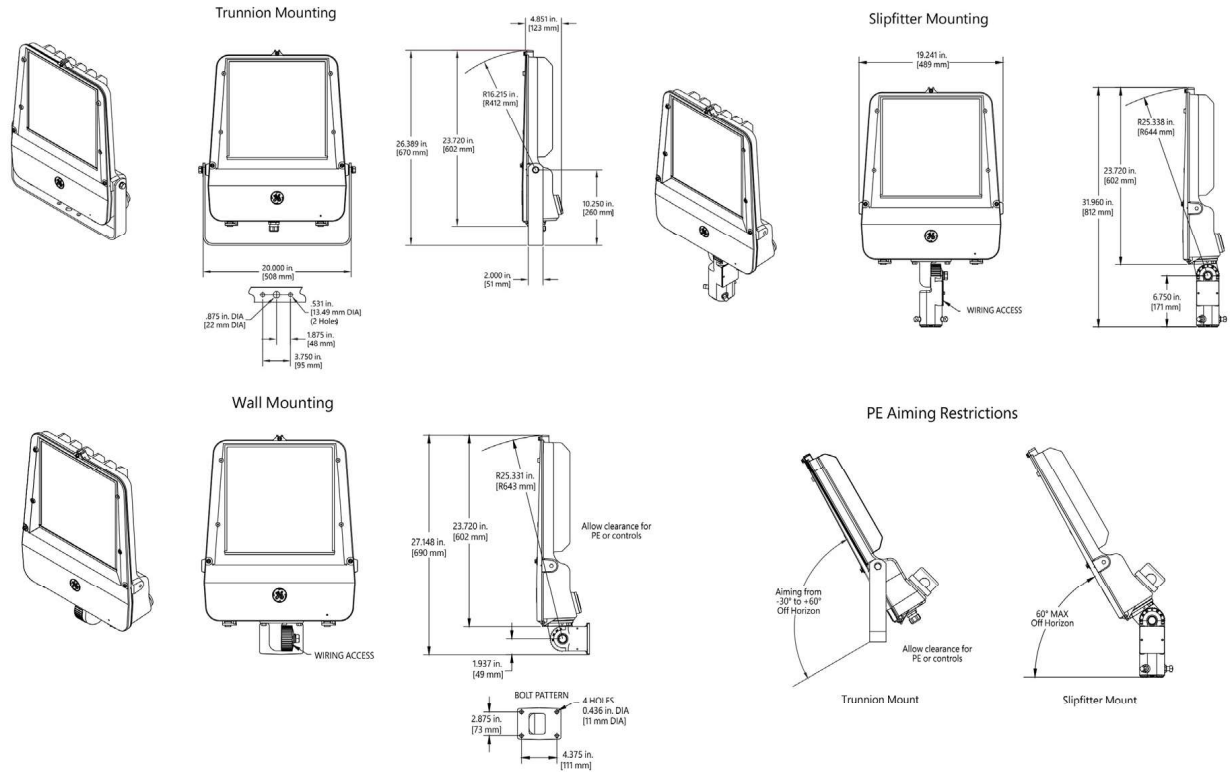

Mounting

Effective Projected Area

Option K

- K1=Knuckle Slipfitter for 2.3 in. OD Tenon. Lead wires exiting tenon.
- K2=Knuckle Slipfitter for 2.3 in. OD Tenon, ext. 3ft #14/3 cord.

Option S

- S1=Knuckle Slipfitter for 2.3 in.-3.0 in. OD Tenon. Lead wires exiting tenon.
- S2=Knuckle Slipfitter for 2.3 in.-3.0 in. OD Tenon, ext. 3ft #14/3 cord.

Option V – V1=Knuckle Wall Mount. Lead wires exiting tenon.

Option T – T1=Trunnion, with external 3ft #14/3 cord.

- Vertical 3.51 sq ft (0.33 sq M) (aimed at horizon)
- Tilted 1.79 sq ft (0.17 sq M) (aimed down 45 degrees)

Shields

SAP Number	Part Number	Description	Color
93033494	TSVBLCK-EFH	Top and Side Visor	Black
93033655	TSVDKBZ-EFH	Top and Side Visor	Dark Bronze
93033493	TSVGRAY-EFH	Top and Side Visor	Gray
93033656	TSVWHITE-EFH	Top and Side Visor	White
93034260	VAN-EFH	Vandal Shield	
93034259	WG-EFH	Wire Guard	
93034837	BDABLCK-EFH	Barn Doors	Black
93034838	BDADKBZ-EFH	Barn Doors	Dark Bronze
93034836	BDAGRAY-EFH	Barn Doors	Gray
93034839	BDAWHITE-EFH	Barn Doors	White

Accessories

SAP Number	Part Number	Description
93123552	WANSI - 277	ANSI C136.41 Dimming PE Daintree Enable, 105-305V
93123553	WANSI - 480	ANSI C136.41 Dimming PE Daintree Enable, 312-530V
93029237	PED-MV-LED-7	ANSI C136.41 Dimming PE, 120-277V
93029238	PED-347-LED-7	ANSI C136.41 Dimming PE, 347V
93029239	PED-480-LED-7	ANSI C136.41 Dimming PE, 480V
28299	PEC0TL	Standard 120-277V
28294	PEC5TL	Standard 480V
80436	PECCTL	Standard 347V
93147530	PECHTL	Long Life Standard PE, 347-480V
73251	SCCL-PECTL	Shorting Cap

