

GE
Lighting

Albeo™ LED Luminaire

Modular High & Low Bay Lighting
(ABH2 - Series)



imagination at work

Product Features

The award winning Albeo™ ABH-series LED Luminaire utilizes innovative heat-sinking and cutting-edge LED technology to deliver a wide range of light outputs that replace 250W-1,500W HID and four-to-eight lamp T5/T8 high intensity fluorescent fixtures in high bay applications. The ABH2-series offers higher efficacy than previous generations and can be matched with motion, daylight and wireless controls for increased energy savings, lower maintenance costs and shorter paybacks.

Applications

- Designed to meet recommended luminance and illuminance requirements for high & low bay lighting applications in industrial and commercial buildings.

Housing

- Die cast aluminum housing.
- Innovative design accommodates up to 6 LED modules.
- Each LED module is equipped with an upper limit thermal control to ensure fixture lifetime throughout the temperature range.

LED & Optical Assembly

- Precision lens system provides optimized illumination for open floor or racked aisles.
- Field upgradable lens and multiple photometric distributions of 20, 30, 40, 80 and 120 degrees.
- Utilizes high brightness LEDs, 70 & 80 CRI at 4000K & 5000K typical.
- LM-79, LM-80 tests and reports are performed in accordance to IESNA standards.

Lumen Maintenance

- System rating is L85 at 50,000 hours. Contact manufacturer for Lxx rating (Lumen Depreciation) beyond 50,000 hours.

Ratings

-  DLC. Listed.
-  UL 1598 Suitable for Damp Locations.
- UL 8750 LED equipment in Lighting Products.
- Temperature Rated:
T, H Output Models: -35C to +55C (-31F to 131F)
V Output Models: -25C to +55C (-13F to 131F)
- Projected L70 (15K) > 100,000 Life Hours per IES TM-21.

Mounting

- Chain or Cable mounting ready. 1/2" threaded rod kit, indirect mount, and 3/4" pendant mount kit optional.
- Cord and plug options offered.

Finish

- White polyester powder coat.

Controls

- Motion and Daylight sensor can be combined for additional energy savings.
- Wireless controls and emergency battery backup options available.

Electrical

- 120-277 volt and 347-480 volt available.
- System power factor is >90% and THD <20%.*
- EMI: Title 47 CFR Part 15 Class A.

** System power factor and THD is tested and specified at 120V input and maximum load conditions.*

Warranty

- 5-year limited system warranty standard.



Industry Awards



Winner of the 2013 Next Generation Luminares™ Solid-State Lighting Design Competition for high and low bay industrial lighting. Sponsored by the U.S. Department of Energy (DOE), Illuminating Engineering Society of North America, and the International Association of Lighting Designers.



Winner of the 2013 Architectural SSL Magazine Product Innovation Award in the high bay category. Recognized with third award in 2 years from Architectural SSL Magazine.

Ordering Number Logic

Albeo™ High & Low Bay LED Lighting (ABH2)



ABH2

W

PRODUCT ID	VOLTAGE	MODULE	DRIVE CURRENT	LED COLOR TEMP	OPTICS BEAM	MOTION/DAYLIGHT SENSOR	CONTROL WIRING	MOUNTING	CORD	PLUG	FINISH	OPTIONS
A = Albeo	0 = 120/277	1 = 1 module	T = Standard	70 Plus CRI	1 = 120°	N = None	N = None	ST = Standard	K = Knock out access	N = None	W = White	W = Wireless
B = Bay	1 = 120*	2 = 2 modules	H = High Output	47 = 4000K	2 = 20°	A = On/off aisle motion	D = 0-10V Daisy Chain	22 = ½" Threaded rod mount kit*	A = 6 ft.	A = 15A Straight Plug	W = White Powder coat	EL1 = 120° Battery Backup
H = H-Series	4 = 277*	3 = 3 modules	V = Very High Output	57 = 5000K	3 = 30°	B = On/off 360 motion	V = 0-10V Stand alone	*Rod and nuts not included	B = 12 ft.	B = 20A Straight Plug		EL5 = 50° Battery Backup
	5 = 480*	4 = 4 modules		80 Plus CRI	4 = 40°	C = On/off cold temp aisle		23 = ¾" Pendant Mount Kit**	18-3 cord	C = 15A Twistlock Plug		
	D = 347*	6 = 6 modules		48 = 4000K	8 = 80°	D = On/off cold temp 360		**Conduit not included	18-3 cord	D = 20A Twistlock Plug		
2 = 2nd Generation	*Specify single voltage if cord and plug or wireless needed.			58 = 5000K	D = 120° Diffused lens	E = Daylight sensor		UP = Indirect Mount				
					F = 30° Diffused lens	F = Aisle motion/daylight		41 = Y-Cable/Hook 5 ft.				
						G = 360 motion/daylight		42 = Y-Cable/Hook 10 ft.				
						H = Pre-wired (no sensor)		43 = Y-Cable/Hook 15 ft.				
								44 = Y-Cable/Hook 20 ft.				
								61 = Indirect Y-Cable/Hook 5 ft.				
								62 = Indirect Y-Cable/Hook 10 ft.				
								63 = Indirect Y-Cable/Hook 15 ft.				
								64 = Indirect Y-Cable/Hook 20 ft.				

MODULE #	DRIVE CURRENT	LED COUNT	TYPICAL INITIAL LUMENS 70 CRI		TYPICAL SYSTEM WATTS		LPW (5000K)	
			4000K	5000K	120V-277V	347V-480V	120V-277V	347V-480V
1	T	24	6000	6175	59	63	105	98
1	H	36	8485	8735	81	87	108	100
1	V	36	9290	9560	90	97	106	99
2	T	48	12000	12350	114	122	108	101
2	H	72	16950	17450	159	171	110	102
2	V	72	18650	19200	179	193	107	99
3	T	72	18000	18530	170	183	109	101
3	H	108	25450	26200	241	259	109	101
3	V	108	28000	28800	270	291	107	99
4	T	96	24000	24700	228	245	108	101
4	H	144	33940	34940	318	342	110	102
4	V	144	37325	38425	359	386	107	100
6	T	144	36000	37050	342	367	108	101
6	H	216	50900	52400	478	514	110	102
6	V	216	55985	57640	539	579	107	100

MODULE #	DRIVE CURRENT	LED COUNT	TYPICAL INITIAL LUMENS 80 CRI		TYPICAL SYSTEM WATTS		LPW (5000K)	
			4000K	5000K	120V-277V	347V-480V	120V-277V	347V-480V
1	T	24	5500	5500	59	63	93	87
1	H	36	7800	7800	81	87	96	90
1	V	36	8550	8550	90	97	95	88
2	T	48	11035	11035	114	122	97	90
2	H	72	15600	15600	159	171	98	91
2	V	72	17150	17150	179	193	96	89
3	T	72	16550	16550	170	183	97	90
3	H	108	23400	23400	241	259	97	90
3	V	108	25750	25750	270	291	95	88
4	T	96	22075	22075	228	245	97	90
4	H	144	31200	31200	318	342	98	91
4	V	144	34330	34330	359	386	96	89
6	T	144	33100	33100	342	367	97	90
6	H	216	46830	46830	478	514	98	91
6	V	216	51500	51500	539	579	96	89

OPTICS BEAM	% OUTPUT
120° (1)	100%
20° (2)	100%
30° (3)	100%
40° (4)	100%
80° (8)	100%
120° Diffused (D)	88%
30° Diffused (F)	100%

Note: Lumen data shown is for 120 (1) optic. See table to the right for other light optic factors.

Photometrics

Optics for Common Applications

Aisle Distribution
20° Full Beam Angle

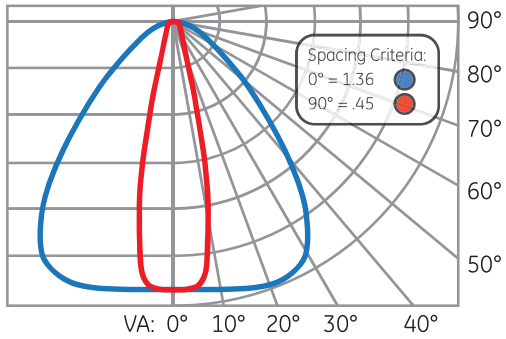

Aisle Distribution
30° Full Beam Angle

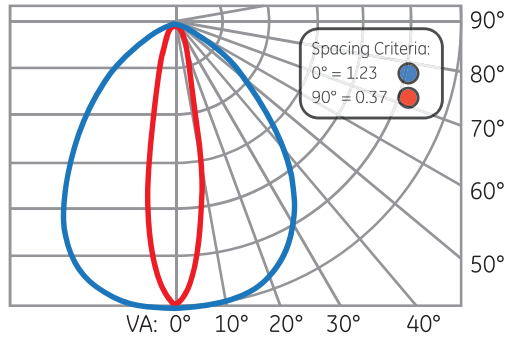

Aisle Distribution
30° Diffuse Angle

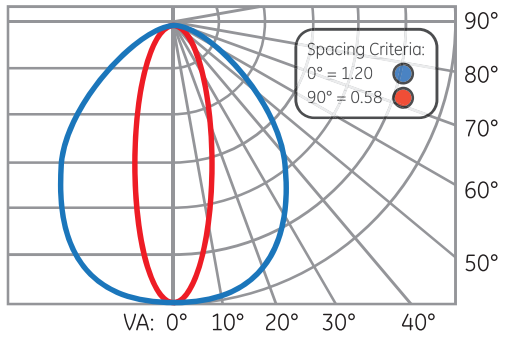

Narrow Distribution
40° Full Beam Angle

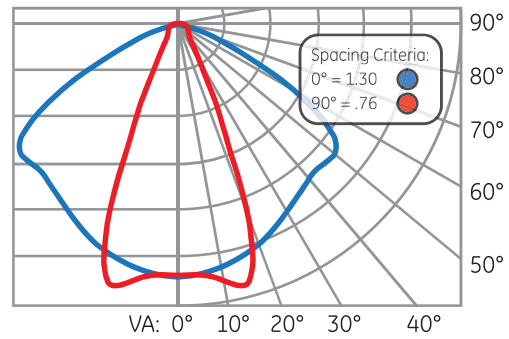

Standard Distribution
80° Full Beam Angle

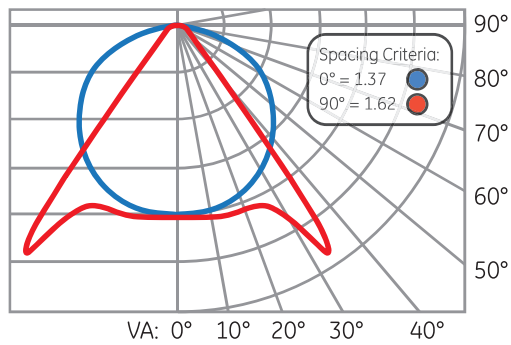

Standard/Diffused Distribution
120° Full Beam Angle

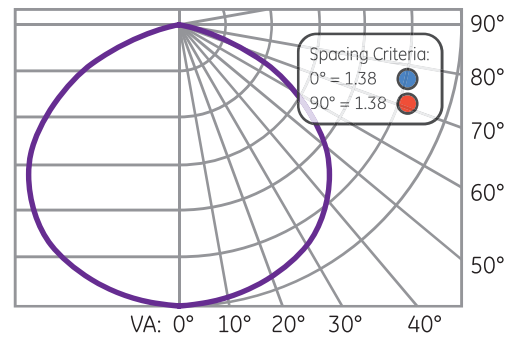

Lens selection by application

The Albeo™ ABHG-series optical lens system enables LEDs to provide precise illumination where needed. Lenses are designed for commercial & industrial applications where mounting height, fixture spacing & light levels help determine lens selection. The following table outlines lens options and suggested application. Consult factory for specific project layouts.

LENS TYPE	MOUNTING HEIGHT	SPACE TYPE
Diffused 120°	Below 20 Feet	Open Floor Plan
Standard 120°	Any	Open Floor Plan
80°	Any	Open Floor Plan
40°	Below 20 feet	Low Bay Racked Aisles
30°	Above 20 feet	High Bay Racked Aisles
20°	Above 20 feet	High Bay Racked Aisles
Diffused 30°	Below 20 feet	Low Bay Racked Aisles



Ambient Temperature Ratings

T, H Output Models: -35C to +55C (-31F to 131F)

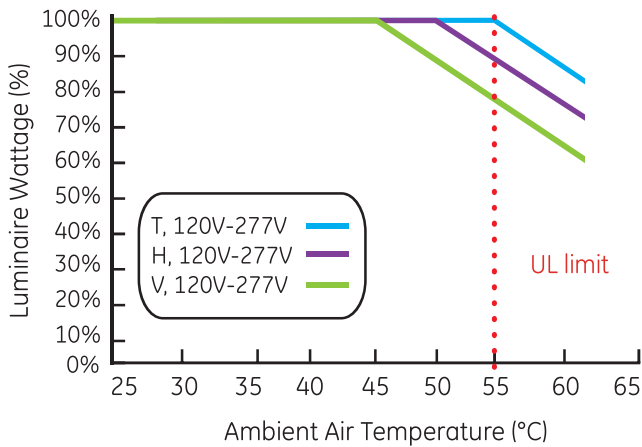
V Output Models: -25C to +55C (-13F to 131F)

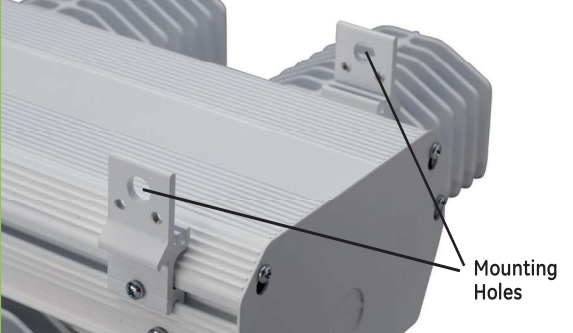
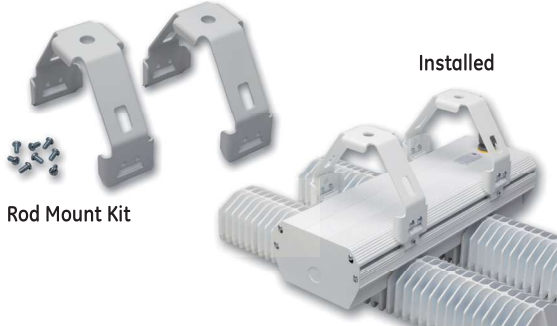
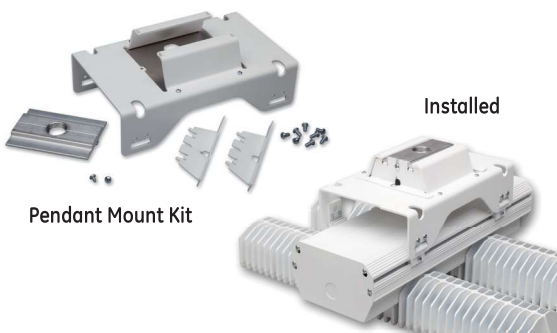
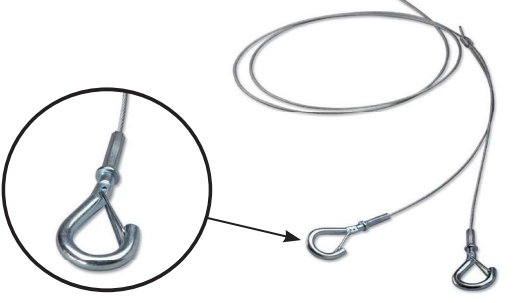

Mounting & Accessories

MOUNTING OPTIONS	IMAGE	ORDER LOGIC CODE
<p>Standard Chain/Cable Mount Available on all fixture configurations (chain not included). Y-Cable w/hook can be ordered as an accessory.</p>	 <p>Mounting Holes</p>	<p>ST = Standard</p>
<p>Rod Mount (optional) Available on all fixture configurations. Attaches to 1/2" threaded rod (rod and nuts not included).</p>	 <p>Rod Mount Kit</p> <p>Installed</p>	<p>22 = 1/2" Threaded Rod Kit</p>
<p>Pendant Mount (optional) Available on all fixture configurations. Attaches to 3/4" threaded conduit (conduit not included).</p>	 <p>Pendant Mount Kit</p> <p>Installed</p>	<p>23 = 3/4" Pendant Mount Kit Note: Cannot be used with 6 module High Output or Very High Output fixture.</p>
<p>Y-Cable w/hook (optional) Use with Standard Mounting Option only. Order separately. Price adder per pair. 5 ft., 10 ft., 15 ft., 20 ft. lengths available.</p>		<p>41=Y-Cable-Hook-05ft-Pair 42=Y-Cable-Hook-10ft-Pair 43=Y-Cable-Hook-15ft-Pair 44=Y-Cable-Hook-20ft-Pair Max Load: 200 lbs. per pair</p>
<p>Indirect Mount Available on all fixture configurations</p>		<p>UP=Indirect (No Y-Cable) 61=Indirect w/05ft Y-Cable 62=Indirect w/10ft Y-Cable 63=Indirect w/15ft Y-Cable 64=Indirect w/20ft Y-Cable Max Load: 200 lbs. per pair</p>

Chain/cable mount is standard and included in price. Price adder for Y-Cable, Rod Mount, Indirect Mount, and Pendant Mount. Consult Sales for latest information. See "Installation Instructions" for mounting details.

Product Dimensions

Albeo™ High & Low Bay LED Lighting (ABH2)

(ABH2 - Series)

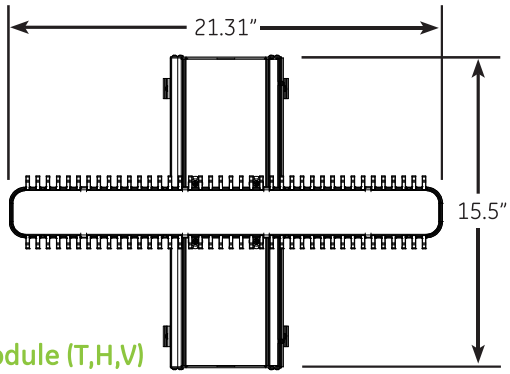

1-Module (T,H,V)

Max. Weight: 17 lbs.

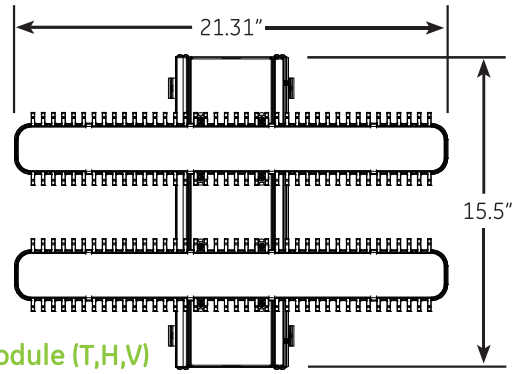

2-Module (T,H,V)

Max. Weight: 21 lbs.

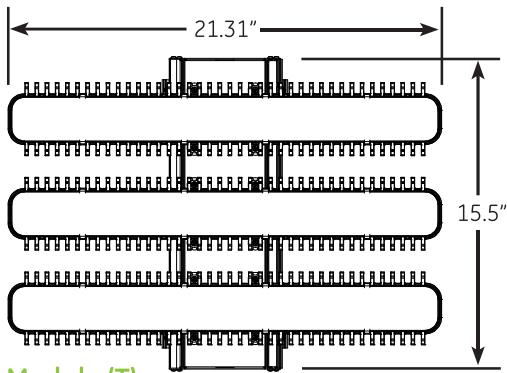

3-Module (T)

Max. Weight: 29 lbs.

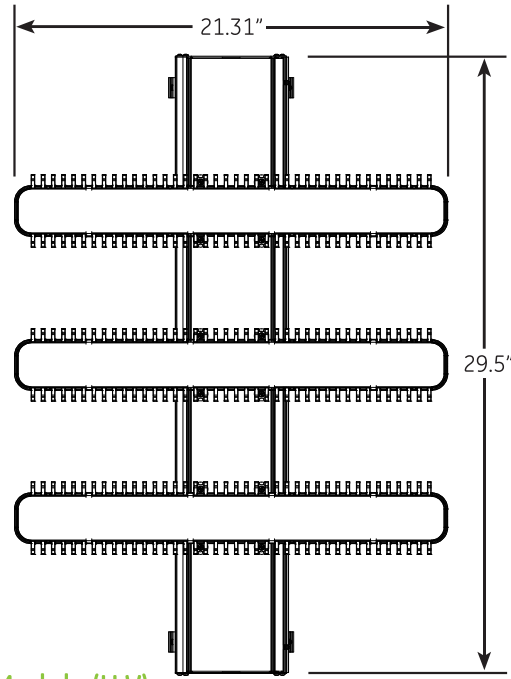

3-Module (H,V)

Max. Weight: 40 lbs.

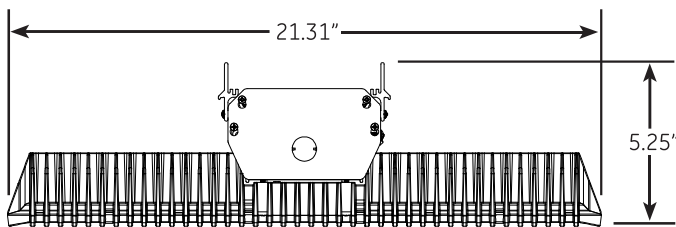

1, 2, 3, 4, & 6-Module (T,H,V) 120/277V

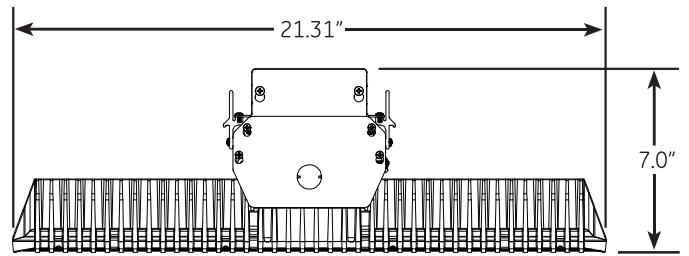

1, 2, 3, 4, & 6-Module (T,H,V) 347/480V

Product Dimensions

Albeo™ High & Low Bay LED Lighting (ABH2)

(ABH2 - Series)

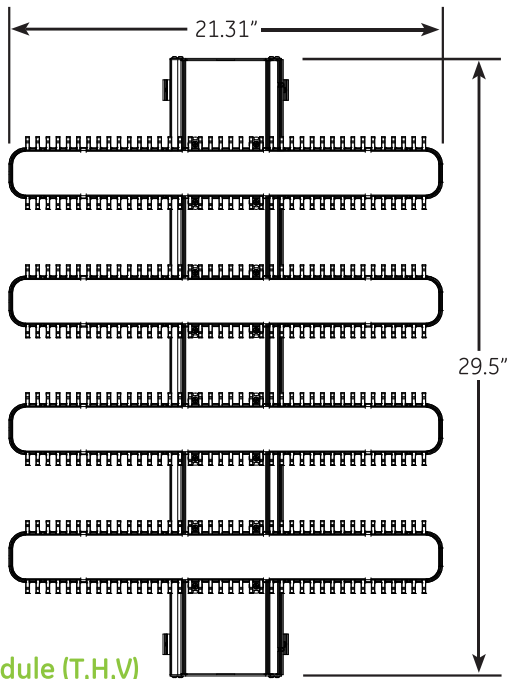

4-Module (T,H,V)

Max. Weight: 43 lbs.

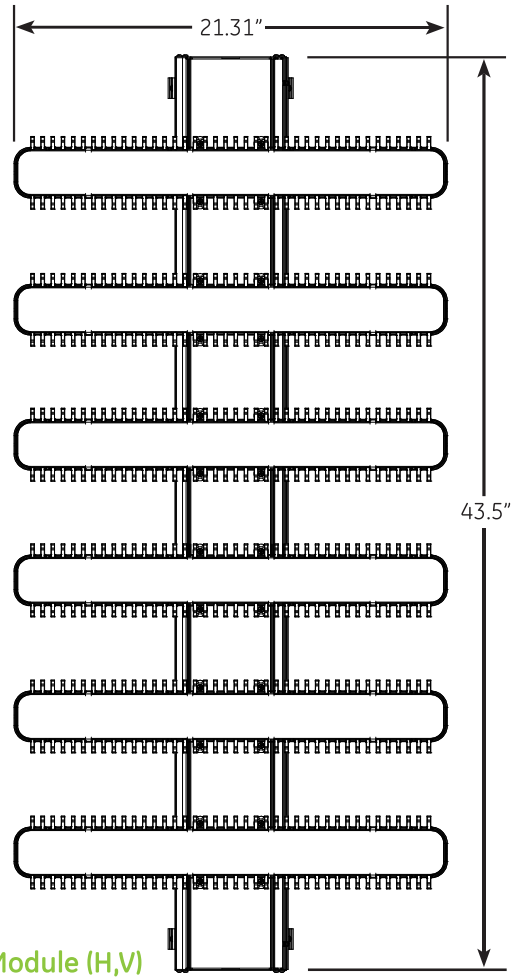

6-Module (H,V)

Max. Weight: 70 lbs.

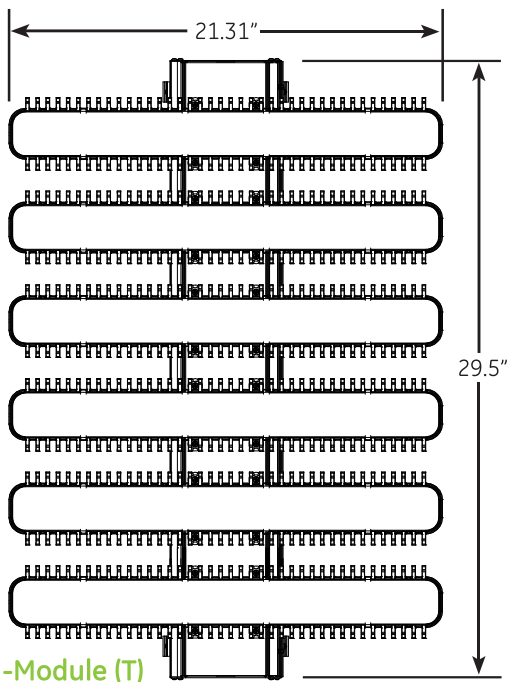

6-Module (T)



www.gelighting.com

GE and the GE Monogram are trademarks of the General Electric Company. All other trademarks are the property of their respective owners. Information provided is subject to change without notice. All values are design or typical values when measured under laboratory conditions. GE Lighting and GE Lighting Solutions, LLC are businesses of the General Electric Company. © 2015 GE.

ALB013 (Rev 06/11/15)